



Saber 3°, 5° y 9° 2012
Cuadernillo de prueba
Segunda edición

Matemáticas
Grado 9°

Presidente de la República
Juan Manuel Santos Calderón

Ministra de Educación Nacional
Gina María Parody d'Echeona

Viceministro de Educación Preescolar, Básica y Media
Víctor Javier Saavedra Mercado

Directora General
Ximena Dueñas Herrera

Secretaria General
María Sofía Arango Arango

Director de Evaluación
Hugo Andrés Gutierrez Rojas

Directora de Producción y Operaciones
Francia María del Pilar Jiménez Franco

Directora de Tecnología
Ingrid Picón Carrascal

Oficina Asesora de Comunicaciones y Mercadeo

Oficina Gestión de Proyectos de Investigación

Subdirector de Producción de Instrumentos
Luis Javier Toro Baquero

Subdirectora de Análisis y Divulgación
Silvana Godoy Mateus

Adaptación y elaboración del documento
Diana Oquendo Victoria
Martha Jeanet Castillo Ballén

Diseño y diagramación
Cecilia Martínez Rodríguez
Nathalia Chavarro Morcote
Alejandra Guzmán Escobar
Gustavo Andrés Álvarez Mejía

ISBN de la versión digital: En trámite

Bogotá D.C., junio de 2016



ADVERTENCIA

Con el fin de evitar la sobrecarga gráfica que supondría utilizar en español “o/a” para denotar uno u otro género, el Icfes opta por emplear el masculino genérico en el que todas las menciones de este se refieren siempre a hombres y mujeres.

Todo el contenido es propiedad exclusiva y reservada del Icfes y es el resultado de investigaciones y obras protegidas por la legislación nacional e internacional. No se autoriza su reproducción, utilización ni explotación a ningún tercero. Solo se autoriza su uso para fines exclusivamente académicos. Esta información no podrá ser alterada, modificada o enmendada.

TÉRMINOS Y CONDICIONES DE USO PARA PUBLICACIONES Y OBRAS DE PROPIEDAD DEL ICYES

El Instituto Colombiano para la Evaluación de la Educación (Icfes) pone a la disposición de la comunidad educativa y del público en general, **DE FORMA GRATUITA Y LIBRE DE CUALQUIER CARGO**, un conjunto de publicaciones a través de su portal www.icfes.gov.co. Dichos materiales y documentos están normados por la presente política y están protegidos por derechos de propiedad intelectual y derechos de autor a favor del Icfes. Si tiene conocimiento de alguna utilización contraria a lo establecido en estas condiciones de uso, por favor infórmenos al correo prensaicfes@icfes.gov.co.

Queda prohibido el uso o publicación total o parcial de este material con fines de lucro. **Únicamente está autorizado su uso para fines académicos e investigativos**. Ninguna persona, natural o jurídica, nacional o internacional, podrá vender, distribuir, alquilar, reproducir, transformar*, promocionar o realizar acción alguna de la cual se lucre directa o indirectamente con este material. Esta publicación cuenta con el registro ISBN (International Standard Book Number, o Número Normalizado Internacional para Libros) que facilita la identificación no solo de cada título, sino de la autoría, la edición, el editor y el país en donde se edita.

En todo caso, cuando se haga uso parcial o total de los contenidos de esta publicación del Icfes, el usuario deberá consignar o hacer referencia a los créditos institucionales del Icfes respetando los derechos de cita; es decir, se podrán utilizar con los fines aquí previstos transcribiendo los pasajes necesarios, citando siempre al Icfes como fuente de autor. Lo anterior siempre que los pasajes no sean tantos y seguidos que razonadamente puedan considerarse como una reproducción simulada y sustancial, que redunde en perjuicio del Icfes.

Asimismo, los logotipos institucionales son marcas registradas y de propiedad exclusiva del Icfes. Por tanto, los terceros no podrán usar las marcas de propiedad del Icfes con signos idénticos o similares respecto de cualesquiera productos o servicios prestados por esta entidad, cuando su uso pueda causar confusión. En todo caso queda prohibido su uso sin previa autorización expresa del Icfes. La infracción de estos derechos se perseguirá civil y, en su caso, penalmente, de acuerdo con las leyes nacionales y tratados internacionales aplicables.

El Icfes realizará cambios o revisiones periódicas a los presentes términos de uso, y los actualizará en esta publicación.

El Icfes adelantará las acciones legales pertinentes por cualquier violación a estas políticas y condiciones de uso.

* La transformación es la modificación de la obra a través de la creación de adaptaciones, traducciones, compilaciones, actualizaciones, revisiones y, en general, cualquier modificación que de la obra se pueda realizar, de modo que la nueva obra resultante se constituya en una obra derivada protegida por el derecho de autor, con la única diferencia respecto de las obras originales de que aquellas requieren para su realización de la autorización expresa del autor o propietario para adaptar, traducir, compilar, etcétera. En este caso, el Icfes prohíbe la transformación de esta publicación.

GRADO 9° - PRUEBA DE MATEMÁTICAS

 Responde las preguntas 1 y 2 de acuerdo con la siguiente información:

Se les preguntó a 32 estudiantes de un colegio por el número de horas que dedican a ver televisión diariamente. Los resultados aparecen en la siguiente lista.

0, 2, 4, 2, 2, 2, 2, 3, 3, 4, 0, 2, 4, 2, 2, 4, 0, 4, 2, 2, 4, 2, 2, 3, 3, 2, 2, 2, 2, 4, 4, 0

• Pregunta 1.

¿Cuál es la moda de esta lista?

- A. 0
- B. 2
- C. 3
- D. 4

• Estructura

Competencia	Planteamiento y resolución de problemas
Componente	Aleatorio
Afirmación	Resolver problemas que requieran el uso e interpretación de medidas de tendencia central para analizar el comportamiento de un conjunto de datos.
Nivel de desempeño	Mínimo
Respuesta Correcta	B

• Resultados a nivel nacional y de Entidad Territorial Certificada (ETC)

ETC/País	A	B	C	D	Omisión y multimarca	N° estudiantes
Amazonas	6.8%	78.5%	5.1%	7.8%	1.7%	410
Antioquia	4.9%	84.1%	3.4%	6.9%	0.7%	13193
Apartadó	5.6%	85.2%	3.5%	5.1%	0.5%	779
Arauca	5.4%	84.7%	3.0%	6.2%	0.7%	1241
Armenia	4.3%	87.7%	2.7%	5.1%	0.2%	1844
Atlántico	7.0%	80.3%	4.1%	7.9%	0.7%	3381
Barrancabermeja	4.4%	86.7%	2.5%	5.8%	0.5%	1305
Barranquilla	5.0%	86.0%	3.0%	5.3%	0.8%	6498
Bello	4.4%	85.9%	3.2%	6.0%	0.5%	2368
Bogotá, D.C.	2.8%	88.3%	1.9%	4.6%	2.4%	46578
Bolívar	8.8%	78.9%	3.8%	7.7%	0.9%	5376
Boyacá	3.6%	86.5%	2.7%	6.9%	0.4%	5619
Bucaramanga	2.2%	91.2%	2.1%	4.2%	0.2%	3739
Buenaventura	7.6%	79.4%	3.7%	8.2%	1.0%	1742
Buga	2.7%	89.4%	1.6%	3.9%	2.4%	635
Caldas	3.9%	84.5%	3.5%	7.8%	0.3%	3338
Cali	4.0%	86.0%	2.5%	6.1%	1.4%	12349
Caquetá	6.0%	84.4%	3.2%	5.9%	0.4%	1128
Cartagena	6.4%	83.9%	3.2%	5.7%	0.8%	6516
Cartago	3.0%	87.7%	2.0%	6.3%	1.2%	608
Casanare	4.6%	86.3%	2.4%	6.2%	0.4%	1433
Cauca	5.9%	79.4%	3.8%	10.1%	0.8%	5696
Cesar	6.3%	83.1%	3.8%	6.5%	0.3%	3686
Chocó	11.2%	69.4%	7.1%	11.0%	1.3%	1417
Chía	2.1%	92.0%	1.5%	4.0%	0.4%	971
Ciénaga	6.6%	78.0%	7.0%	8.0%	0.4%	747
Cundinamarca	3.5%	87.3%	2.3%	6.3%	0.6%	9588
Córdoba	8.6%	77.0%	5.2%	8.4%	0.8%	6073
Cúcuta	3.4%	87.5%	2.5%	6.3%	0.2%	4355
Dosquebradas	2.8%	89.4%	1.9%	5.3%	0.6%	931
Duitama	3.4%	89.3%	2.2%	4.8%	0.3%	951
Envigado	3.1%	90.7%	1.9%	3.8%	0.5%	1332
Facatativá	4.0%	88.7%	2.0%	5.1%	0.1%	791
Florencia	4.9%	85.7%	3.2%	5.4%	0.8%	932
Floridablanca	3.0%	91.4%	1.7%	3.5%	0.4%	1551
Fusagasugá	3.0%	88.6%	3.2%	5.0%	0.1%	854
Girardot	4.1%	84.4%	5.1%	5.3%	1.1%	731

Continúa en la siguiente página



ETC/País	A	B	C	D	Omisión y multimarca	N° estudiantes
Girón	2.8%	89.4%	2.9%	4.1%	0.8%	716
Guainía	0.0%	50.0%	50.0%	0.0%	0.0%	2
Guaviare	5.1%	84.4%	2.6%	6.7%	1.2%	495
Huila	4.0%	86.6%	2.8%	6.4%	0.3%	4000
Ibagué	2.8%	89.1%	2.6%	5.1%	0.4%	3313
Ipiales	3.6%	85.9%	3.2%	5.9%	1.4%	725
Itagüí	5.8%	86.5%	2.8%	4.2%	0.7%	1267
Jamundí	7.3%	81.1%	3.2%	7.6%	0.7%	684
La Guajira	6.8%	81.0%	4.1%	6.6%	1.5%	1358
Lorica	11.1%	74.1%	5.2%	8.9%	0.8%	931
Magangué	6.5%	84.2%	3.1%	5.9%	0.4%	751
Magdalena	9.4%	75.6%	5.4%	8.7%	0.9%	3737
Maicao	8.2%	80.0%	3.5%	6.9%	1.3%	850
Malambo	6.4%	81.0%	5.0%	7.1%	0.5%	563
Manizales	3.8%	87.9%	2.3%	5.7%	0.3%	2369
Medellín	4.2%	87.2%	2.5%	5.3%	0.8%	13275
Meta	3.9%	84.7%	3.0%	7.5%	0.9%	2478
Montería	6.2%	83.3%	3.3%	6.0%	1.2%	2840
Mosquera	2.5%	90.5%	2.1%	4.9%	0.0%	771
Nariño	5.9%	80.7%	4.2%	7.3%	1.8%	4306
Neiva	3.5%	88.1%	2.5%	5.9%	0.0%	2436
Norte de Santander	4.0%	85.9%	2.9%	6.4%	0.8%	3660
Palmira	3.2%	87.4%	2.7%	6.0%	0.7%	1677
Pasto	4.1%	86.5%	2.9%	6.2%	0.3%	2706
Pereira	3.6%	88.1%	2.5%	5.2%	0.6%	2789
Piedecuesta	4.6%	88.5%	2.1%	4.1%	0.7%	855
Pitalito	3.7%	89.0%	2.5%	4.7%	0.1%	763
Popayán	3.6%	86.9%	2.2%	5.9%	1.3%	1832
Putumayo	5.8%	82.2%	3.1%	8.3%	0.6%	1989
Quibdó	7.7%	76.7%	5.2%	7.6%	2.7%	878
Quindío	4.8%	83.6%	3.7%	7.5%	0.4%	1688
Riohacha	8.2%	82.6%	4.0%	4.7%	0.5%	958
Rionegro	2.8%	90.0%	2.0%	4.8%	0.4%	830
Risaralda	3.7%	85.5%	3.7%	6.5%	0.5%	1501
Sabaneta	2.9%	91.2%	2.9%	2.9%	0.0%	377
Sahagún	7.3%	80.8%	3.9%	7.5%	0.5%	791
San Andrés	6.2%	83.3%	2.5%	5.4%	2.5%	354
Santa Marta	6.0%	83.3%	3.8%	6.3%	0.6%	2899
Santander	4.3%	87.4%	2.5%	5.3%	0.4%	4612

Continúa en la siguiente página

ETC/País	A	B	C	D	Omisión y multimarca	N° estudiantes
Sincelejo	5.2%	86.7%	2.9%	4.8%	0.3%	2119
Soacha	3.7%	87.3%	2.8%	5.8%	0.5%	3300
Sogamoso	3.1%	91.0%	1.6%	4.3%	0.1%	964
Soledad	4.6%	85.9%	3.6%	5.3%	0.5%	2583
Sucre	7.5%	78.5%	4.5%	9.0%	0.4%	3938
Tolima	5.5%	82.2%	3.7%	8.1%	0.5%	5129
Tuluá	3.3%	86.1%	3.8%	6.5%	0.4%	1315
Tumaco	7.6%	77.4%	5.0%	9.2%	0.8%	872
Tunja	2.6%	90.5%	2.1%	4.3%	0.5%	1175
Turbo	7.6%	78.5%	4.4%	8.7%	0.9%	804
Uribe	7.4%	82.6%	1.3%	8.1%	0.7%	149
Valle del Cauca	4.8%	82.2%	3.7%	8.3%	1.0%	4706
Valledupar	4.9%	85.7%	2.9%	5.5%	0.9%	2690
Vaupés	0.0%	25.0%	25.0%	0.0%	50.0%	4
Vichada	4.4%	79.9%	5.2%	8.3%	2.2%	229
Villavicencio	3.4%	88.9%	2.1%	5.2%	0.4%	3070
Yopal	4.6%	88.7%	1.4%	5.3%	0.1%	988
Yumbo	4.7%	85.2%	2.3%	7.2%	0.5%	737
Zipaquirá	2.7%	90.7%	1.9%	4.5%	0.2%	852
Colombia	4.6%	85.3%	2.9%	6.1%	1.0%	275336

*Es posible que los porcentajes mostrados no sumen exactamente 100 debido a aproximaciones decimales.

• **Pregunta 2.**

¿En cuál de los siguientes diagramas circulares se representa correctamente la información de la lista?

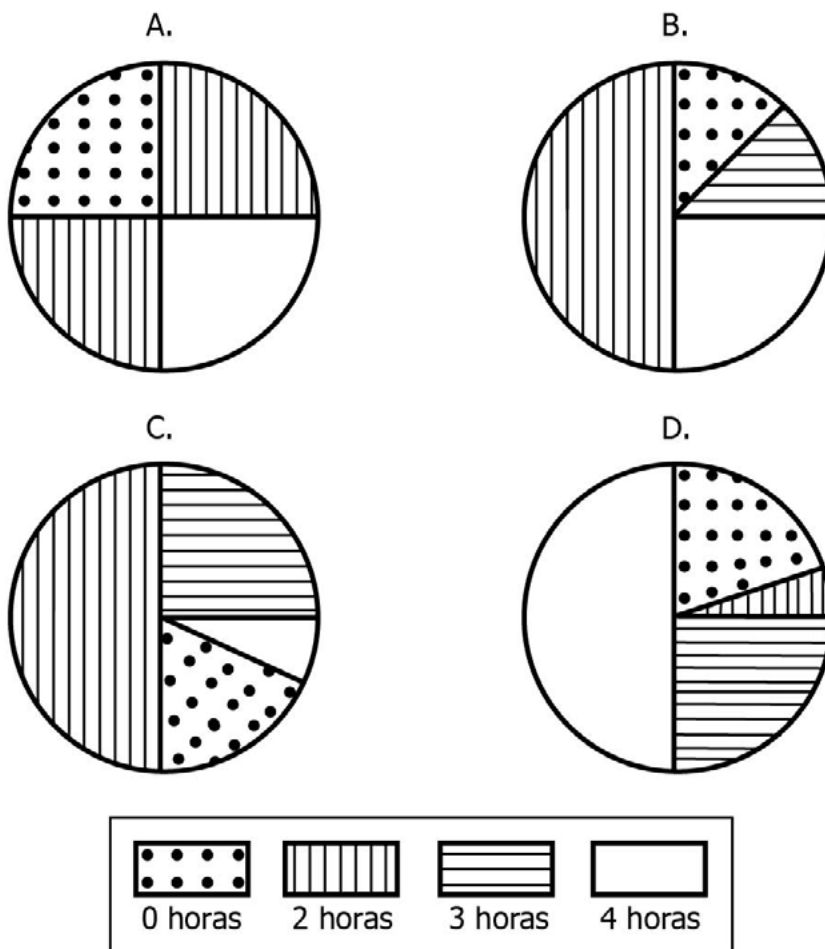

• Estructura

Competencia	Comunicación, representación y modelación
Componente	Aleatorio
Afirmación	Reconocer relaciones entre diferentes representaciones de un conjunto de datos y analizar la pertinencia de la representación.
Nivel de desempeño	Satisfactorio
Respuesta Correcta	B

• Resultados a nivel nacional y de Entidad Territorial Certificada (ETC)

ETC/País	A	B	C	D	Omisión y multimarca	N° estudiantes
Amazonas	11.5%	50.7%	18.0%	17.8%	2.0%	410
Antioquia	9.4%	58.8%	17.7%	13.2%	0.9%	13193
Apartadó	9.2%	58.5%	16.9%	14.9%	0.4%	779
Arauca	5.0%	69.5%	12.1%	12.8%	0.6%	1241
Armenia	6.2%	69.3%	13.2%	11.0%	0.3%	1844
Atlántico	11.7%	54.0%	18.5%	15.2%	0.6%	3381
Barrancabermeja	8.2%	64.7%	14.0%	12.6%	0.5%	1305
Barranquilla	7.5%	65.7%	13.2%	12.7%	0.9%	6498
Bello	6.5%	66.2%	15.0%	11.7%	0.6%	2368
Bogotá, D.C.	3.7%	73.0%	11.0%	9.8%	2.5%	46578
Bolívar	11.8%	50.8%	19.2%	17.2%	1.0%	5376
Boyacá	6.3%	68.0%	15.2%	10.1%	0.4%	5619
Bucaramanga	3.4%	75.3%	10.4%	10.4%	0.4%	3739
Buenaventura	11.7%	52.0%	18.1%	16.6%	1.5%	1742
Buga	6.9%	63.5%	16.1%	11.2%	2.4%	635
Caldas	6.8%	62.9%	16.1%	13.9%	0.3%	3338
Cali	5.9%	67.4%	13.0%	12.3%	1.4%	12349
Caquetá	12.0%	57.5%	16.7%	12.9%	1.0%	1128
Cartagena	8.0%	61.0%	14.3%	15.8%	0.9%	6516
Cartago	5.9%	64.6%	14.0%	14.6%	0.8%	608
Casanare	8.1%	63.7%	14.9%	13.0%	0.3%	1433
Cauca	12.1%	52.0%	18.4%	16.4%	1.1%	5696
Cesar	9.3%	56.2%	17.4%	16.5%	0.6%	3686
Chocó	16.7%	39.7%	23.3%	19.1%	1.3%	1417
Chía	2.8%	78.3%	10.3%	8.2%	0.4%	971
Ciénaga	13.7%	50.1%	21.2%	14.3%	0.8%	747
Cundinamarca	4.9%	69.8%	13.8%	10.8%	0.7%	9588

Continúa en la siguiente página



ETC/País	A	B	C	D	Omisión y multimarca	N° estudiantes
Córdoba	12.8%	51.2%	20.1%	15.1%	0.9%	6073
Cúcuta	5.2%	70.0%	11.0%	13.5%	0.3%	4355
Dosquebradas	5.6%	68.4%	12.1%	13.2%	0.6%	931
Duitama	2.9%	81.0%	8.7%	6.9%	0.4%	951
Envigado	4.4%	73.9%	12.1%	9.1%	0.6%	1332
Facatativá	4.6%	70.8%	14.4%	10.0%	0.3%	791
Florencia	7.9%	66.5%	13.4%	11.5%	0.6%	932
Floridablanca	3.7%	76.7%	9.7%	9.4%	0.5%	1551
Fusagasugá	3.4%	73.3%	10.9%	11.6%	0.8%	854
Girardot	7.3%	60.9%	14.2%	16.6%	1.1%	731
Girón	4.2%	74.3%	11.0%	9.4%	1.1%	716
Guainía	50.0%	0.0%	50.0%	0.0%	0.0%	2
Guaviare	11.1%	55.6%	18.0%	14.3%	1.0%	495
Huila	6.0%	66.7%	14.4%	12.6%	0.4%	4000
Ibagué	4.6%	73.5%	11.2%	10.1%	0.6%	3313
Ipiales	5.0%	73.1%	14.2%	6.8%	1.0%	725
Itagüí	6.4%	67.1%	14.8%	10.9%	0.8%	1267
Jamundí	9.5%	57.6%	18.7%	13.0%	1.2%	684
La Guajira	11.2%	53.8%	18.0%	15.5%	1.5%	1358
Lorica	13.0%	44.3%	22.8%	19.1%	0.9%	931
Magangué	10.9%	57.9%	18.0%	12.5%	0.7%	751
Magdalena	14.5%	46.5%	20.4%	17.6%	1.0%	3737
Maicao	9.3%	56.2%	18.4%	14.7%	1.4%	850
Malambo	8.0%	55.4%	19.4%	16.3%	0.9%	563
Manizales	5.6%	68.8%	14.1%	11.2%	0.3%	2369
Medellín	6.3%	67.0%	14.1%	11.7%	0.8%	13275
Meta	7.1%	64.9%	13.7%	13.2%	1.1%	2478
Montería	8.0%	63.5%	14.3%	12.9%	1.3%	2840
Mosquera	5.4%	74.2%	10.6%	9.7%	0.0%	771
Nariño	8.1%	64.0%	13.8%	12.1%	1.9%	4306
Neiva	4.9%	72.8%	10.7%	11.4%	0.2%	2436
Norte de Santander	7.4%	65.7%	15.1%	11.1%	0.7%	3660
Palmira	4.8%	69.5%	12.5%	12.4%	0.8%	1677
Pasto	4.1%	73.3%	11.2%	11.0%	0.3%	2706
Pereira	5.5%	68.7%	12.7%	12.6%	0.6%	2789
Piedecuesta	5.3%	68.0%	14.0%	11.6%	1.2%	855
Pitalito	4.3%	72.5%	13.0%	10.0%	0.3%	763
Popayán	4.7%	68.7%	12.9%	12.3%	1.4%	1832
Putumayo	6.9%	64.4%	13.3%	14.6%	0.9%	1989

Continúa en la siguiente página

ETC/País	A	B	C	D	Omisión y multimarca	N° estudiantes
Quibdó	15.8%	47.0%	20.5%	13.9%	2.7%	878
Quindío	6.5%	67.0%	14.6%	11.6%	0.4%	1688
Riohacha	10.9%	53.2%	19.8%	15.3%	0.7%	958
Rionegro	4.9%	73.7%	12.4%	8.4%	0.5%	830
Risaralda	7.3%	63.2%	16.0%	12.9%	0.6%	1501
Sabaneta	5.3%	73.5%	12.7%	8.2%	0.3%	377
Sahagún	9.2%	60.1%	19.2%	11.1%	0.4%	791
San Andrés	8.2%	57.9%	15.3%	15.8%	2.8%	354
Santa Marta	9.9%	57.4%	17.1%	14.7%	0.9%	2899
Santander	6.0%	68.9%	13.0%	11.6%	0.4%	4612
Sincelejo	6.8%	66.7%	12.7%	13.2%	0.7%	2119
Soacha	5.7%	70.6%	12.1%	10.9%	0.6%	3300
Sogamoso	3.0%	75.8%	10.0%	11.1%	0.1%	964
Soledad	8.1%	61.2%	15.7%	14.3%	0.7%	2583
Sucre	12.1%	52.4%	19.0%	15.8%	0.6%	3938
Tolima	8.4%	58.3%	16.9%	15.8%	0.6%	5129
Tuluá	9.3%	63.3%	14.4%	12.4%	0.5%	1315
Tumaco	10.9%	53.6%	18.8%	15.5%	1.3%	872
Tunja	2.9%	77.3%	12.7%	6.8%	0.3%	1175
Turbo	14.1%	47.3%	21.8%	15.8%	1.1%	804
Uribe	10.7%	55.7%	19.5%	13.4%	0.7%	149
Valle del Cauca	7.8%	59.0%	16.0%	16.2%	1.0%	4706
Valledupar	8.6%	61.0%	15.7%	13.8%	1.0%	2690
Vaupés	25.0%	25.0%	0.0%	0.0%	50.0%	4
Vichada	13.1%	45.9%	21.8%	17.9%	1.3%	229
Villavicencio	4.8%	70.7%	12.7%	11.2%	0.5%	3070
Yopal	4.6%	71.7%	11.3%	12.1%	0.3%	988
Yumbo	6.1%	65.9%	15.1%	12.3%	0.5%	737
Zipaquirá	3.9%	77.5%	9.7%	8.8%	0.1%	852
Colombia	7.0%	65.1%	14.3%	12.5%	1.1%	275336

*Es posible que los porcentajes mostrados no sumen exactamente 100 debido a aproximaciones decimales.

• **Pregunta 3.**

La figura 1 muestra la temperatura ambiente de un lugar a las 5:00 de la mañana, la figura 2 muestra la temperatura ambiente del mismo lugar a la 1:00 de la tarde y la figura 3 muestra la temperatura ambiente del mismo lugar a las 6:00 de la tarde.



Figura 1

Figura 2

Figura 3

¿Cuál fue el cambio de temperatura ambiente del lugar entre las 5:00 de la mañana y las 6:00 de la tarde?

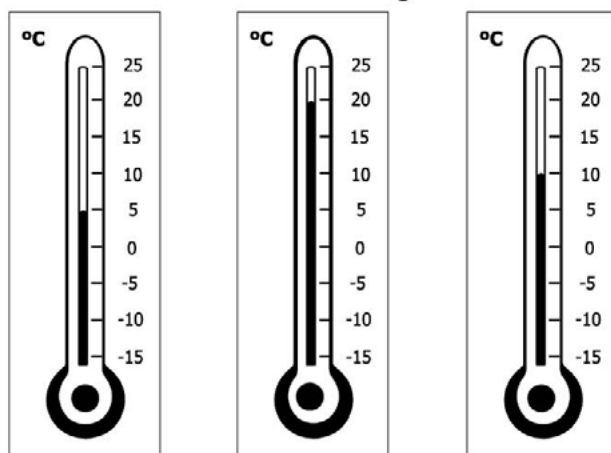
- A. Disminuyó 15° C.
- B. Disminuyó en 10° C.
- C. Aumentó 5° C.
- D. Aumentó 20° C.

- Estructura

Competencia	Planteamiento y resolución de problemas
Componente	Numérico - variacional
Afirmación	Resolver problemas en situaciones aditivas y multiplicativas en el conjunto de los números reales
Nivel de desempeño	Mínimo
Respuesta Correcta	C

- Resultados a nivel nacional y de Entidad Territorial Certificada (ETC)

ETC	A	B	C	D	Omisión y multimarca	N° estudiantes
Amazonas	10.5%	18.0%	56.8%	13.2%	1.5%	410
Antioquia	7.0%	13.4%	67.7%	11.0%	0.9%	13193
Apartadó	8.6%	17.2%	60.5%	12.8%	0.9%	779
Arauca	6.0%	10.3%	72.7%	10.4%	0.6%	1241
Armenia	5.7%	14.0%	71.6%	8.4%	0.3%	1844
Atlántico	7.4%	16.2%	60.3%	15.4%	0.7%	3381
Barrancabermeja	6.8%	13.9%	68.4%	10.2%	0.6%	1305
Barranquilla	6.6%	13.2%	69.0%	10.4%	0.8%	6498
Bello	6.8%	12.1%	71.0%	9.6%	0.5%	2368
Bogotá, D.C.	4.5%	9.4%	75.8%	7.8%	2.5%	46578
Bolívar	9.2%	18.7%	55.8%	15.3%	1.0%	5376
Boyacá	4.8%	10.8%	74.9%	9.1%	0.4%	5619
Bucaramanga	4.1%	9.6%	78.8%	7.2%	0.4%	3739
Buenaventura	9.2%	17.9%	58.3%	13.3%	1.3%	1742
Buga	6.5%	15.7%	64.9%	10.2%	2.7%	635
Caldas	6.6%	13.2%	70.2%	9.5%	0.5%	3338
Cali	6.4%	12.9%	69.3%	9.9%	1.5%	12349
Caquetá	6.4%	13.2%	68.4%	11.0%	1.0%	1128
Cartagena	8.0%	15.7%	64.1%	11.3%	1.0%	6516
Cartago	7.7%	11.2%	71.7%	8.1%	1.3%	608
Casanare	5.8%	12.1%	70.3%	11.0%	0.8%	1433
Cauca	7.4%	15.0%	63.8%	12.8%	0.9%	5696
Cesar	8.3%	14.2%	64.2%	12.8%	0.5%	3686
Chocó	9.8%	19.0%	50.4%	19.2%	1.6%	1417
Chía	4.7%	8.9%	79.3%	6.7%	0.4%	971
Ciénaga	9.9%	17.8%	58.4%	13.4%	0.5%	747

Continúa en la siguiente página



ETC	A	B	C	D	Omisión y multimarca	N° estudiantes
Cundinamarca	5.0%	9.6%	75.0%	9.9%	0.6%	9588
Córdoba	8.6%	16.9%	57.4%	16.2%	0.9%	6073
Cúcuta	6.0%	11.8%	73.7%	8.1%	0.4%	4355
Dosquebradas	5.0%	9.3%	75.5%	8.9%	1.2%	931
Duitama	4.8%	7.2%	81.0%	6.5%	0.5%	951
Envigado	4.7%	8.9%	78.8%	7.0%	0.7%	1332
Facatativá	5.3%	11.6%	75.5%	7.5%	0.1%	791
Florencia	6.3%	9.8%	71.9%	10.9%	1.1%	932
Floridablanca	3.4%	10.3%	76.9%	9.0%	0.5%	1551
Fusagasugá	4.4%	11.2%	74.5%	9.5%	0.4%	854
Girardot	10.1%	11.1%	65.7%	12.0%	1.1%	731
Girón	6.7%	8.7%	74.9%	8.7%	1.1%	716
Guainía	0.0%	0.0%	50.0%	50.0%	0.0%	2
Guaviare	6.3%	12.9%	68.7%	10.7%	1.4%	495
Huila	6.5%	11.9%	71.5%	9.9%	0.2%	4000
Ibagué	5.9%	10.4%	73.2%	10.1%	0.5%	3313
Ipiales	6.6%	10.6%	73.4%	8.0%	1.4%	725
Itagüí	7.1%	13.3%	68.1%	10.7%	0.7%	1267
Jamundí	6.7%	17.3%	60.7%	14.9%	0.4%	684
La Guajira	7.8%	15.8%	60.8%	13.9%	1.8%	1358
Lorica	9.6%	19.1%	56.6%	14.5%	0.2%	931
Magangué	7.3%	15.8%	63.2%	13.2%	0.4%	751
Magdalena	9.4%	17.8%	55.7%	16.0%	1.1%	3737
Maicao	10.4%	15.6%	59.2%	13.3%	1.5%	850
Malambo	9.1%	14.7%	62.3%	12.6%	1.2%	563
Manizales	6.0%	12.5%	72.5%	8.6%	0.5%	2369
Medellín	6.5%	11.9%	71.7%	9.0%	0.9%	13275
Meta	5.9%	13.0%	69.0%	10.9%	1.1%	2478
Montería	7.9%	14.5%	63.7%	12.6%	1.4%	2840
Mosquera	3.4%	10.8%	77.6%	7.9%	0.4%	771
Nariño	5.6%	11.8%	71.6%	9.3%	1.6%	4306
Neiva	6.0%	11.6%	72.2%	9.8%	0.3%	2436
Norte de Santander	6.0%	11.1%	73.1%	9.2%	0.6%	3660
Palmira	6.7%	13.1%	69.5%	10.0%	0.8%	1677
Pasto	5.2%	11.1%	75.6%	7.8%	0.3%	2706
Pereira	5.8%	10.9%	73.2%	9.3%	0.8%	2789
Piedecuesta	6.4%	10.1%	74.2%	8.5%	0.8%	855
Pitalito	5.6%	10.0%	73.9%	10.4%	0.1%	763
Popayán	4.8%	12.3%	72.4%	9.1%	1.3%	1832

Continúa en la siguiente página

ETC	A	B	C	D	Omisión y multimarca	N° estudiantes
Putumayo	6.0%	11.9%	72.4%	8.8%	0.9%	1989
Quibdó	10.0%	17.1%	56.2%	13.4%	3.3%	878
Quindío	7.5%	11.2%	69.3%	11.6%	0.4%	1688
Riohacha	9.2%	16.7%	60.2%	13.3%	0.6%	958
Rionegro	5.1%	9.6%	77.8%	7.1%	0.4%	830
Risaralda	7.9%	12.3%	69.1%	10.3%	0.4%	1501
Sabaneta	6.4%	11.9%	72.9%	8.8%	0.0%	377
Sahagún	8.8%	16.2%	63.1%	11.6%	0.3%	791
San Andrés	6.8%	15.3%	60.2%	15.3%	2.5%	354
Santa Marta	8.1%	15.1%	63.8%	12.0%	1.0%	2899
Santander	5.1%	9.3%	76.3%	8.8%	0.5%	4612
Sincelejo	7.2%	14.1%	66.6%	11.7%	0.5%	2119
Soacha	5.2%	10.7%	74.8%	9.0%	0.2%	3300
Sogamoso	3.4%	7.7%	80.7%	8.0%	0.2%	964
Soledad	7.0%	13.7%	68.6%	9.9%	0.9%	2583
Sucre	9.4%	16.2%	58.2%	15.4%	0.8%	3938
Tolima	7.1%	14.1%	66.0%	12.0%	0.8%	5129
Tuluá	6.2%	14.2%	69.0%	10.3%	0.3%	1315
Tumaco	10.4%	17.3%	55.3%	15.4%	1.6%	872
Tunja	3.8%	6.6%	82.6%	6.4%	0.6%	1175
Turbo	9.3%	16.0%	56.1%	17.0%	1.5%	804
Uribe	9.4%	14.8%	59.1%	16.1%	0.7%	149
Valle del Cauca	7.7%	14.7%	64.6%	12.0%	1.1%	4706
Valledupar	7.1%	14.9%	64.6%	12.5%	0.9%	2690
Vaupés	0.0%	50.0%	0.0%	0.0%	50.0%	4
Vichada	7.0%	14.4%	64.6%	12.7%	1.3%	229
Villavicencio	6.1%	10.6%	73.5%	9.5%	0.3%	3070
Yopal	6.0%	9.6%	74.0%	10.1%	0.3%	988
Yumbo	6.5%	10.9%	71.4%	10.6%	0.7%	737
Zipaquirá	3.1%	9.5%	78.3%	8.9%	0.2%	852
Colombia	6.3%	12.4%	69.8%	10.3%	1.1%	275336

*Es posible que los porcentajes mostrados no sumen exactamente 100 debido a aproximaciones decimales.



 Responde las preguntas 4,5 y 6 de acuerdo con la siguiente información:

La siguiente gráfica muestra la relación entre la velocidad de un molino y el tiempo de funcionamiento en un día.

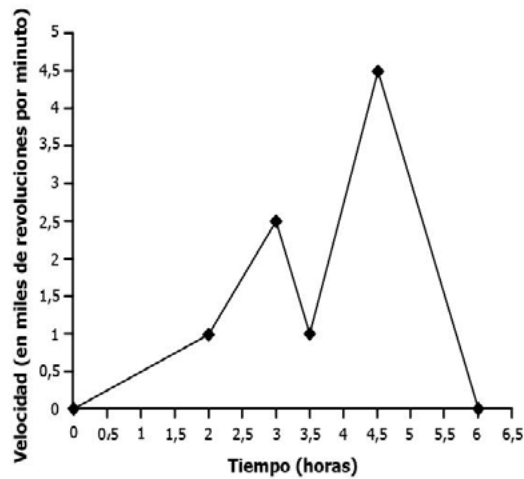

• **Pregunta 4.**

El molino aumentó más rápidamente su velocidad entre

- A. la hora 2 y la hora 3
- B. la hora 3 y la hora 3,5
- C. la hora 3,5 y la hora 4,5
- D. la hora 4,5 y la hora 6

• **Estructura**

Competencia	Razonamiento y argumentación
Componente	Numérico - variacional
Afirmación	Interpretar tendencias que se presentan en una situación de variación.
Nivel de desempeño	Satisfactorio
Respuesta Correcta	C

• Resultados a nivel nacional y de Entidad Territorial Certificada (ETC)

ETC/País	A	B	C	D	Omisión y multimarca	N° estudiantes
Amazonas	4.1%	4.4%	44.1%	45.4%	2.0%	410
Antioquia	5.8%	5.1%	52.2%	36.0%	0.9%	13193
Apartadó	8.1%	5.9%	49.2%	35.9%	0.9%	779
Arauca	4.3%	4.4%	59.3%	31.4%	0.6%	1241
Armenia	5.3%	4.2%	62.1%	27.7%	0.7%	1844
Atlántico	7.6%	5.1%	48.0%	38.3%	1.0%	3381
Barrancabermeja	7.3%	5.4%	56.4%	30.3%	0.6%	1305
Barranquilla	6.4%	5.4%	56.3%	30.9%	1.0%	6498
Bello	6.0%	5.6%	57.2%	30.5%	0.7%	2368
Bogotá, D.C.	3.7%	2.9%	68.2%	22.6%	2.5%	46578
Bolívar	7.3%	7.2%	40.7%	43.6%	1.3%	5376
Boyacá	3.7%	3.5%	60.4%	31.8%	0.6%	5619
Bucaramanga	3.8%	2.9%	71.1%	21.8%	0.5%	3739
Buenaventura	7.5%	8.0%	42.1%	41.2%	1.3%	1742
Buga	5.4%	4.1%	57.5%	30.1%	3.0%	635
Caldas	4.6%	4.6%	56.4%	33.9%	0.6%	3338
Cali	5.2%	4.4%	60.8%	27.9%	1.7%	12349
Caquetá	5.8%	4.6%	49.9%	38.5%	1.2%	1128
Cartagena	6.5%	6.1%	52.0%	34.3%	1.0%	6516
Cartago	4.3%	3.0%	61.7%	29.1%	2.0%	608
Casanare	3.3%	4.5%	56.1%	35.9%	0.2%	1433
Cauca	5.4%	5.0%	47.1%	41.3%	1.3%	5696
Cesar	5.4%	6.0%	49.6%	38.5%	0.4%	3686
Chocó	9.8%	9.1%	34.6%	44.7%	1.8%	1417
Chía	3.8%	2.0%	71.3%	22.6%	0.4%	971
Ciénaga	8.7%	7.2%	43.1%	39.4%	1.6%	747
Cundinamarca	3.7%	2.8%	63.5%	29.4%	0.6%	9588
Córdoba	6.5%	6.6%	43.3%	42.5%	1.1%	6073
Cúcuta	4.9%	4.2%	61.2%	29.1%	0.6%	4355
Dosquebradas	4.9%	4.3%	62.4%	27.3%	1.1%	931
Duitama	2.5%	2.6%	70.0%	24.1%	0.7%	951
Envigado	4.4%	3.2%	70.0%	21.2%	1.2%	1332
Facatativá	4.9%	3.3%	65.9%	25.4%	0.5%	791
Florencia	4.8%	3.6%	58.2%	32.5%	0.9%	932
Floridablanca	3.7%	2.6%	69.8%	23.5%	0.4%	1551
Fusagasugá	4.2%	3.6%	66.6%	24.5%	1.1%	854
Girardot	6.0%	7.5%	56.6%	28.7%	1.1%	731

Continúa en la siguiente página



ETC/País	A	B	C	D	Omisión y multimarca	N° estudiantes
Girón	3.6%	2.9%	66.3%	26.0%	1.1%	716
Guainía	0.0%	0.0%	50.0%	50.0%	0.0%	2
Guaviare	4.6%	3.6%	50.3%	39.6%	1.8%	495
Huila	4.7%	3.4%	57.5%	34.2%	0.2%	4000
Ibagué	4.6%	3.0%	65.1%	26.7%	0.6%	3313
Ipiales	4.3%	5.2%	60.7%	28.3%	1.5%	725
Itagüí	6.5%	4.7%	57.6%	30.1%	1.1%	1267
Jamundí	6.3%	4.8%	52.2%	35.8%	0.9%	684
La Guajira	5.2%	7.3%	45.2%	40.4%	1.8%	1358
Lorica	6.1%	7.8%	40.7%	44.7%	0.6%	931
Magangué	4.9%	4.5%	47.3%	42.7%	0.5%	751
Magdalena	7.3%	6.7%	38.5%	46.4%	1.1%	3737
Maicao	8.4%	7.6%	44.2%	38.1%	1.6%	850
Malambo	6.2%	7.1%	50.4%	35.3%	0.9%	563
Manizales	5.4%	3.4%	59.7%	30.7%	0.8%	2369
Medellín	5.6%	4.4%	60.4%	28.5%	1.0%	13275
Meta	5.2%	4.3%	55.0%	34.3%	1.1%	2478
Montería	5.9%	4.6%	52.1%	35.7%	1.8%	2840
Mosquera	3.5%	3.2%	69.0%	24.0%	0.3%	771
Nariño	4.5%	3.8%	54.5%	35.2%	2.0%	4306
Neiva	3.9%	3.2%	67.4%	25.3%	0.3%	2436
Norte de Santander	5.1%	3.9%	55.6%	34.6%	0.8%	3660
Palmira	5.0%	4.8%	65.3%	24.2%	0.7%	1677
Pasto	3.7%	3.0%	67.5%	25.2%	0.6%	2706
Pereira	3.8%	3.5%	66.0%	26.0%	0.7%	2789
Piedecuesta	4.8%	3.0%	63.6%	27.4%	1.2%	855
Pitalito	2.8%	3.0%	64.1%	29.9%	0.3%	763
Popayán	4.3%	2.6%	61.4%	30.4%	1.3%	1832
Putumayo	3.4%	4.0%	58.2%	33.4%	1.0%	1989
Quibdó	7.9%	7.2%	36.9%	44.5%	3.5%	878
Quindío	6.2%	5.0%	57.2%	31.3%	0.4%	1688
Riohacha	6.8%	5.9%	48.1%	38.7%	0.4%	958
Rionegro	2.9%	3.1%	64.9%	28.4%	0.6%	830
Risaralda	4.6%	3.1%	58.2%	33.5%	0.7%	1501
Sabaneta	2.7%	2.9%	72.9%	21.2%	0.3%	377
Sahagún	5.4%	7.0%	45.0%	41.6%	1.0%	791
San Andrés	8.2%	4.0%	54.0%	31.4%	2.5%	354
Santa Marta	7.2%	6.9%	51.0%	33.9%	1.1%	2899
Santander	3.9%	2.9%	60.5%	32.1%	0.6%	4612

Continúa en la siguiente página

ETC/País	A	B	C	D	Omisión y multimarca	N° estudiantes
Sincelejo	4.8%	5.7%	55.4%	33.8%	0.3%	2119
Soacha	4.4%	4.1%	61.1%	29.8%	0.7%	3300
Sogamoso	2.7%	1.8%	71.5%	23.9%	0.2%	964
Soledad	6.0%	6.1%	57.8%	29.2%	0.9%	2583
Sucre	6.4%	6.4%	43.2%	43.1%	0.8%	3938
Tolima	4.9%	4.4%	54.0%	35.9%	0.9%	5129
Tuluá	5.4%	4.2%	58.3%	31.6%	0.6%	1315
Tumaco	6.8%	5.6%	40.1%	46.2%	1.3%	872
Tunja	2.6%	2.8%	74.0%	20.3%	0.3%	1175
Turbo	8.2%	6.5%	39.9%	44.3%	1.1%	804
Uribe	17.4%	6.7%	37.6%	38.3%	0.0%	149
Valle del Cauca	5.7%	5.0%	54.0%	33.9%	1.4%	4706
Valledupar	7.9%	4.4%	51.0%	35.7%	1.0%	2690
Vaupés	25.0%	0.0%	0.0%	25.0%	50.0%	4
Vichada	3.9%	2.2%	41.0%	51.1%	1.7%	229
Villavicencio	4.3%	3.9%	63.7%	27.5%	0.5%	3070
Yopal	3.7%	2.8%	64.9%	28.2%	0.3%	988
Yumbo	6.0%	4.3%	59.7%	29.3%	0.7%	737
Zipaquirá	2.8%	1.8%	70.8%	24.5%	0.1%	852
Colombia	5.1%	4.3%	58.2%	31.2%	1.2%	275336

*Es posible que los porcentajes mostrados no sumen exactamente 100 debido a aproximaciones decimales.



• **Pregunta 5.**

¿Qué expresión representa la relación entre la velocidad (v) y el tiempo (t) durante la primera hora y media de funcionamiento del molino?

- A. $v = \frac{t}{2}$
- B. $v = \frac{t}{3}$
- C. $v = t + 3$
- D. $v = t - 3$

• **Estructura**

Competencia	Comunicación, representación y modelación
Componente	Numérico - variacional
Afirmación	Identificar características de gráficas cartesianas en relación con la situación que representan.
Nivel de desempeño	Sastisfactorio
Respuesta Correcta	A

• Resultados a nivel nacional y de Entidad Territorial Certificada (ETC)

ETC/País	A	B	C	D	Omisión y multimarca	N° estudiantes
Amazonas	34.4%	23.4%	32.9%	7.1%	2.2%	410
Antioquia	41.9%	27.0%	22.5%	7.1%	1.5%	13193
Apartadó	39.8%	29.3%	22.5%	7.3%	1.2%	779
Arauca	48.0%	26.2%	18.5%	6.0%	1.3%	1241
Armenia	47.8%	26.8%	16.7%	7.8%	0.9%	1844
Atlántico	40.2%	25.5%	23.9%	8.6%	1.8%	3381
Barrancabermeja	47.7%	25.2%	19.3%	6.4%	1.5%	1305
Barranquilla	47.6%	26.2%	17.2%	7.3%	1.6%	6498
Bello	44.3%	28.5%	19.3%	6.5%	1.5%	2368
Bogotá, D.C.	49.5%	26.0%	15.4%	5.7%	3.4%	46578
Bolívar	38.7%	26.9%	24.8%	8.1%	1.5%	5376
Boyacá	48.2%	26.7%	18.2%	6.4%	0.6%	5619
Bucaramanga	53.8%	25.1%	14.0%	5.7%	1.4%	3739
Buenaventura	37.7%	27.0%	24.5%	8.5%	2.3%	1742
Buga	40.0%	29.4%	21.7%	5.8%	3.0%	635
Caldas	42.4%	26.8%	21.7%	8.2%	0.9%	3338
Cali	45.8%	26.1%	19.0%	6.5%	2.7%	12349
Caquetá	40.9%	29.0%	21.7%	7.1%	1.3%	1128
Cartagena	43.9%	27.1%	20.2%	6.9%	2.0%	6516
Cartago	52.0%	26.5%	15.8%	4.4%	1.3%	608
Casanare	46.4%	27.4%	19.0%	6.3%	0.9%	1433
Cauca	40.0%	25.0%	25.2%	7.9%	1.8%	5696
Cesar	43.4%	25.9%	21.8%	7.9%	1.1%	3686
Chocó	31.5%	25.1%	31.3%	10.6%	1.5%	1417
Chía	52.9%	25.8%	12.9%	7.0%	1.3%	971
Ciénaga	37.1%	30.7%	23.3%	7.5%	1.5%	747
Cundinamarca	48.6%	26.1%	17.9%	6.3%	1.2%	9588
Córdoba	37.9%	26.7%	25.6%	8.5%	1.3%	6073
Cúcuta	49.4%	28.5%	15.1%	5.7%	1.3%	4355
Dosquebradas	49.0%	25.5%	17.0%	7.1%	1.5%	931
Duitama	58.6%	24.0%	13.0%	3.7%	0.7%	951
Envigado	52.4%	26.5%	13.7%	5.6%	1.7%	1332
Facatativá	47.7%	28.4%	16.8%	6.4%	0.6%	791
Florencia	47.1%	24.2%	20.0%	7.5%	1.2%	932
Floridablanca	52.5%	25.1%	15.4%	5.3%	1.7%	1551
Fusagasugá	54.1%	24.9%	15.1%	5.0%	0.8%	854
Girardot	42.8%	25.6%	20.7%	7.8%	3.1%	731

Continúa en la siguiente página



ETC/País	A	B	C	D	Omisión y multimarca	N° estudiantes
Girón	50.6%	29.7%	13.0%	4.6%	2.1%	716
Guainía	0.0%	50.0%	50.0%	0.0%	0.0%	2
Guaviare	41.8%	24.6%	23.0%	8.7%	1.8%	495
Huila	47.2%	26.4%	18.7%	6.9%	0.7%	4000
Ibagué	47.1%	26.3%	18.2%	6.9%	1.4%	3313
Ipiales	50.6%	25.1%	16.8%	5.8%	1.7%	725
Itagüí	46.0%	25.7%	19.7%	7.2%	1.5%	1267
Jamundí	41.5%	25.9%	23.7%	7.5%	1.5%	684
La Guajira	40.5%	24.4%	26.4%	6.8%	2.0%	1358
Lorica	35.7%	26.9%	26.6%	10.0%	0.9%	931
Magangué	38.1%	28.4%	23.7%	8.4%	1.5%	751
Magdalena	35.1%	27.3%	27.6%	8.5%	1.6%	3737
Maicao	42.1%	26.1%	22.7%	7.9%	1.2%	850
Malambo	43.9%	25.4%	21.0%	7.6%	2.1%	563
Manizales	46.1%	26.8%	18.3%	7.8%	1.1%	2369
Medellín	45.8%	26.6%	19.5%	6.5%	1.6%	13275
Meta	44.1%	26.8%	20.2%	7.4%	1.5%	2478
Montería	46.3%	26.5%	18.4%	6.1%	2.6%	2840
Mosquera	45.5%	27.5%	17.3%	8.4%	1.3%	771
Nariño	50.0%	23.5%	17.9%	6.3%	2.4%	4306
Neiva	50.5%	24.6%	17.7%	6.4%	0.8%	2436
Norte de Santander	48.7%	24.7%	19.1%	6.4%	1.2%	3660
Palmira	48.5%	27.2%	16.6%	5.8%	1.8%	1677
Pasto	52.5%	24.7%	15.9%	5.7%	1.2%	2706
Pereira	47.9%	27.0%	18.1%	6.1%	0.9%	2789
Piedecuesta	50.1%	26.1%	17.2%	4.8%	1.9%	855
Pitalito	47.8%	26.5%	18.5%	6.3%	0.9%	763
Popayán	48.3%	25.9%	17.2%	5.7%	2.9%	1832
Putumayo	48.2%	25.3%	18.2%	6.4%	1.8%	1989
Quibdó	33.6%	26.9%	28.0%	8.3%	3.2%	878
Quindío	45.7%	25.4%	20.3%	7.6%	1.0%	1688
Riohacha	42.3%	27.1%	22.3%	6.9%	1.4%	958
Rionegro	51.0%	25.2%	14.5%	8.2%	1.2%	830
Risaralda	45.4%	26.2%	20.1%	7.8%	0.5%	1501
Sabaneta	48.8%	27.6%	16.4%	5.8%	1.3%	377
Sahagún	43.2%	24.5%	23.0%	9.0%	0.3%	791
San Andrés	38.7%	33.3%	15.8%	9.0%	3.1%	354
Santa Marta	37.6%	27.1%	24.9%	8.7%	1.6%	2899
Santander	49.4%	24.8%	17.6%	7.3%	0.9%	4612

Continúa en la siguiente página

ETC/País	A	B	C	D	Omisión y multimarca	N° estudiantes
Sincelejo	49.6%	24.2%	19.3%	5.8%	1.1%	2119
Soacha	49.2%	26.3%	17.5%	5.8%	1.3%	3300
Sogamoso	56.8%	26.8%	11.3%	4.5%	0.6%	964
Soledad	43.4%	28.7%	19.4%	6.9%	1.6%	2583
Sucre	38.5%	26.5%	25.3%	8.6%	1.1%	3938
Tolima	41.4%	27.3%	22.4%	7.8%	1.1%	5129
Tuluá	44.4%	26.8%	19.6%	7.8%	1.3%	1315
Tumaco	37.2%	24.3%	28.2%	8.0%	2.3%	872
Tunja	58.4%	24.3%	11.1%	4.7%	1.4%	1175
Turbo	32.8%	26.0%	31.0%	8.8%	1.4%	804
Uribe	33.6%	32.2%	26.2%	8.1%	0.0%	149
Valle del Cauca	41.4%	26.9%	21.5%	8.1%	2.0%	4706
Valledupar	41.7%	26.7%	21.4%	8.3%	1.9%	2690
Vaupés	0.0%	25.0%	25.0%	0.0%	50.0%	4
Vichada	36.7%	28.8%	27.5%	4.8%	2.2%	229
Villavicencio	49.7%	26.4%	16.5%	6.3%	1.2%	3070
Yopal	46.5%	27.8%	18.0%	6.5%	1.2%	988
Yumbo	44.6%	27.4%	19.1%	7.1%	1.8%	737
Zipaquirá	50.1%	24.9%	15.6%	8.3%	1.1%	852
Colombia	45.8%	26.3%	19.3%	6.8%	1.8%	275336

*Es posible que los porcentajes mostrados no sumen exactamente 100 debido a aproximaciones decimales.



- **Pregunta 6.**

¿Cuánto tiempo transcurre, desde el momento en que el molino empieza a disminuir su velocidad **por primera vez**, hasta cuando vuelve a aumentarla?

- A. 0,5 horas.
- B. 1,5 horas.
- C. 3,5 horas.
- D. 6 horas.

- **Estructura**

Competencia	Comunicación, representación y modelación
Componente	Numérico - variacional
Afirmación	Identificar características de gráficas cartesianas en relación con la situación que representan.
Nivel de desempeño	Avanzado
Respuesta Correcta	A

• Resultados a nivel nacional y de Entidad Territorial Certificada (ETC)

ETC/País	A	B	C	D	Omisión y multimarca	N° estudiantes
Amazonas	19.3%	19.3%	38.8%	21.2%	1.5%	410
Antioquia	23.0%	21.0%	38.1%	17.1%	0.8%	13193
Apartadó	22.3%	23.6%	37.1%	16.3%	0.6%	779
Arauca	23.6%	20.0%	41.3%	14.6%	0.6%	1241
Armenia	26.0%	23.3%	38.2%	12.3%	0.2%	1844
Atlántico	22.4%	21.4%	37.8%	17.7%	0.7%	3381
Barrancabermeja	23.9%	24.5%	38.5%	12.4%	0.7%	1305
Barranquilla	23.6%	22.1%	39.7%	13.8%	0.9%	6498
Bello	25.9%	22.7%	37.4%	13.5%	0.5%	2368
Bogotá, D.C.	28.8%	24.0%	35.7%	8.9%	2.5%	46578
Bolívar	18.3%	19.4%	38.2%	23.0%	1.1%	5376
Boyacá	23.4%	22.7%	40.0%	13.5%	0.4%	5619
Bucaramanga	30.7%	26.2%	34.7%	8.0%	0.3%	3739
Buenaventura	19.3%	22.0%	36.3%	20.4%	1.9%	1742
Buga	24.6%	20.8%	35.7%	16.2%	2.7%	635
Caldas	23.1%	21.9%	39.7%	14.9%	0.4%	3338
Cali	24.9%	22.5%	38.4%	12.5%	1.7%	12349
Caquetá	25.1%	21.3%	36.0%	17.1%	0.5%	1128
Cartagena	23.3%	22.1%	37.2%	16.4%	1.0%	6516
Cartago	25.8%	21.1%	41.6%	10.7%	0.8%	608
Casanare	23.3%	22.9%	36.9%	16.4%	0.5%	1433
Cauca	20.9%	18.7%	40.0%	19.4%	1.0%	5696
Cesar	21.3%	18.9%	41.2%	18.1%	0.5%	3686
Chocó	17.1%	20.3%	35.5%	25.5%	1.7%	1417
Chía	33.0%	26.6%	34.2%	5.9%	0.4%	971
Ciénaga	21.3%	22.2%	35.1%	21.0%	0.4%	747
Cundinamarca	26.4%	22.1%	39.3%	11.7%	0.5%	9588
Córdoba	19.1%	20.5%	38.5%	21.0%	0.9%	6073
Cúcuta	26.5%	22.4%	38.6%	12.1%	0.4%	4355
Dosquebradas	27.9%	20.4%	39.7%	11.3%	0.6%	931
Duitama	34.4%	24.5%	33.3%	7.3%	0.5%	951
Envigado	38.1%	23.0%	29.1%	8.9%	0.8%	1332
Facatativá	26.3%	24.7%	38.1%	10.7%	0.3%	791
Florencia	22.1%	22.4%	41.8%	13.0%	0.6%	932
Floridablanca	29.7%	23.1%	36.9%	9.8%	0.5%	1551
Fusagasugá	27.0%	25.5%	36.7%	10.3%	0.5%	854
Girardot	21.9%	22.7%	42.1%	11.8%	1.5%	731

Continúa en la siguiente página



ETC/País	A	B	C	D	Omisión y multimarca	N° estudiantes
Girón	27.2%	24.0%	37.3%	10.6%	0.8%	716
Guainía	0.0%	50.0%	0.0%	50.0%	0.0%	2
Guaviare	17.2%	25.3%	37.8%	18.4%	1.4%	495
Huila	22.5%	20.2%	44.0%	13.1%	0.3%	4000
Ibagué	25.2%	21.6%	41.6%	11.0%	0.6%	3313
Ipiales	25.8%	23.7%	39.0%	10.2%	1.2%	725
Itagüí	25.5%	24.7%	35.8%	13.0%	0.9%	1267
Jamundí	18.0%	23.5%	41.8%	15.9%	0.7%	684
La Guajira	19.9%	19.4%	39.5%	19.9%	1.4%	1358
Lorica	18.3%	21.5%	39.1%	20.4%	0.8%	931
Magangué	18.8%	20.6%	40.1%	19.8%	0.7%	751
Magdalena	18.9%	18.5%	39.7%	21.6%	1.3%	3737
Maicao	20.2%	19.3%	39.2%	19.8%	1.5%	850
Malambo	22.2%	21.1%	38.2%	17.2%	1.2%	563
Manizales	27.4%	23.3%	37.3%	11.5%	0.5%	2369
Medellín	26.6%	22.8%	37.2%	12.5%	0.8%	13275
Meta	22.0%	22.0%	40.9%	14.0%	1.1%	2478
Montería	24.0%	20.9%	38.3%	15.5%	1.4%	2840
Mosquera	28.7%	23.6%	39.3%	8.2%	0.3%	771
Nariño	24.3%	18.7%	39.1%	16.0%	1.9%	4306
Neiva	25.9%	22.5%	39.8%	11.6%	0.2%	2436
Norte de Santander	23.9%	19.5%	40.5%	15.4%	0.7%	3660
Palmira	26.1%	22.1%	39.1%	11.9%	0.8%	1677
Pasto	27.8%	22.7%	38.0%	11.3%	0.3%	2706
Pereira	27.1%	22.8%	37.9%	11.6%	0.5%	2789
Piedecuesta	25.8%	21.9%	41.2%	10.3%	0.8%	855
Pitalito	24.2%	24.4%	40.2%	11.0%	0.1%	763
Popayán	23.5%	22.1%	39.7%	13.5%	1.1%	1832
Putumayo	23.4%	20.6%	39.4%	15.5%	1.1%	1989
Quibdó	19.5%	22.6%	32.2%	22.7%	3.1%	878
Quindío	22.6%	21.5%	40.5%	15.0%	0.4%	1688
Riohacha	20.3%	19.8%	37.6%	21.9%	0.4%	958
Rionegro	32.5%	23.7%	32.9%	10.4%	0.5%	830
Risaralda	24.7%	18.6%	40.2%	16.1%	0.5%	1501
Sabaneta	34.0%	23.9%	33.2%	9.0%	0.0%	377
Sahagún	21.2%	19.5%	41.6%	17.4%	0.3%	791
San Andrés	21.5%	21.5%	38.7%	15.8%	2.5%	354
Santa Marta	20.9%	23.8%	39.1%	15.1%	1.1%	2899
Santander	26.4%	21.8%	38.6%	12.7%	0.4%	4612

Continúa en la siguiente página

ETC/País	A	B	C	D	Omisión y multimarca	N° estudiantes
Sincelejo	24.8%	20.4%	38.1%	16.1%	0.6%	2119
Soacha	24.9%	22.6%	39.8%	12.3%	0.4%	3300
Sogamoso	31.7%	22.7%	37.3%	8.0%	0.2%	964
Soledad	23.3%	21.6%	41.2%	13.2%	0.7%	2583
Sucre	18.7%	20.5%	37.4%	22.8%	0.7%	3938
Tolima	21.1%	19.5%	41.3%	17.4%	0.6%	5129
Tuluá	21.3%	21.3%	41.4%	15.7%	0.4%	1315
Tumaco	18.3%	20.8%	35.9%	23.6%	1.4%	872
Tunja	30.4%	25.5%	34.6%	9.1%	0.3%	1175
Turbo	19.8%	20.6%	36.8%	21.5%	1.2%	804
Uribe	14.8%	20.8%	41.6%	22.1%	0.7%	149
Valle del Cauca	21.8%	20.6%	41.5%	15.0%	1.1%	4706
Valledupar	20.6%	19.6%	41.3%	17.4%	1.0%	2690
Vaupés	0.0%	0.0%	50.0%	0.0%	50.0%	4
Vichada	17.5%	18.8%	37.6%	23.6%	2.6%	229
Villavicencio	28.7%	21.9%	37.4%	11.8%	0.3%	3070
Yopal	24.6%	25.3%	38.7%	11.2%	0.2%	988
Yumbo	22.0%	22.5%	42.1%	12.5%	0.9%	737
Zipaquirá	28.9%	25.4%	36.9%	8.8%	0.1%	852
Colombia	24.7%	22.0%	38.2%	13.9%	1.1%	275336

*Es posible que los porcentajes mostrados no sumen exactamente 100 debido a aproximaciones decimales.



 Responde las preguntas 7 y 8 de acuerdo con la siguiente información:

En una feria se juega tiro al blanco: por cada acierto se ganan \$3.000 y por cada desacierto se pierden \$1.000.

- **Pregunta 7.**

Arturo lanzó tres veces y acertó una vez en el blanco. ¿Cuánto dinero ganó o perdió al final de los tres lanzamientos?

- A. Ganó \$ 1.000
- B. Ganó \$ 3.000
- C. Perdió \$ 2.000
- D. Perdió \$ 4.000

- **Estructura**

Competencia	Planteamiento y resolución de problemas
Componente	Numérico - variacional
Afirmación	Resolver problemas en situaciones de variación con funciones polinómicas y exponenciales en contextos aritméticos y geométricos.
Nivel de desempeño	Satisfactorio
Respuesta Correcta	A

• Resultados a nivel nacional y de Entidad Territorial Certificada (ETC)

ETC/País	A	B	C	D	Omisión y multimarca	N° estudiantes
Amazonas	37.1%	25.4%	28.0%	7.6%	2.0%	410
Antioquia	56.0%	14.9%	24.9%	3.2%	1.1%	13193
Apartadó	51.5%	19.0%	24.8%	3.3%	1.4%	779
Arauca	61.1%	14.2%	21.4%	2.5%	0.8%	1241
Armenia	60.8%	12.6%	23.5%	2.7%	0.4%	1844
Atlántico	44.9%	20.6%	28.3%	5.1%	1.1%	3381
Barrancabermeja	54.0%	16.6%	26.1%	2.3%	0.9%	1305
Barranquilla	55.5%	16.3%	24.1%	3.3%	0.9%	6498
Bello	57.6%	14.2%	24.7%	2.8%	0.7%	2368
Bogotá, D.C.	64.0%	12.2%	19.6%	1.6%	2.6%	46578
Bolívar	42.8%	21.0%	28.6%	6.2%	1.4%	5376
Boyacá	62.9%	13.7%	20.6%	2.3%	0.6%	5619
Bucaramanga	68.5%	10.7%	18.9%	1.6%	0.4%	3739
Buenaventura	44.0%	20.4%	27.7%	5.3%	2.5%	1742
Buga	54.3%	15.7%	24.6%	2.7%	2.7%	635
Caldas	56.9%	14.2%	25.1%	3.2%	0.6%	3338
Cali	56.5%	15.3%	24.0%	2.5%	1.7%	12349
Caquetá	56.9%	16.2%	23.0%	2.7%	1.1%	1128
Cartagena	49.1%	19.3%	26.4%	4.3%	1.0%	6516
Cartago	54.6%	14.8%	27.3%	1.6%	1.6%	608
Casanare	60.1%	14.9%	21.7%	2.7%	0.6%	1433
Cauca	52.0%	19.6%	23.7%	3.4%	1.2%	5696
Cesar	51.8%	18.4%	24.8%	3.9%	1.1%	3686
Chocó	40.4%	21.3%	28.6%	6.9%	2.8%	1417
Chía	68.7%	10.0%	19.6%	1.2%	0.5%	971
Ciénaga	49.0%	20.6%	26.0%	3.9%	0.5%	747
Cundinamarca	63.6%	13.2%	20.8%	1.8%	0.6%	9588
Córdoba	46.2%	20.0%	27.4%	5.2%	1.2%	6073
Cúcuta	60.2%	15.4%	21.4%	2.4%	0.5%	4355
Dosquebradas	61.3%	14.6%	21.3%	1.8%	1.0%	931
Duitama	70.8%	9.5%	18.6%	0.8%	0.3%	951
Envigado	69.3%	9.9%	17.7%	2.1%	1.0%	1332
Facatativá	64.0%	12.6%	21.2%	1.9%	0.3%	791
Florencia	57.9%	15.2%	22.4%	2.9%	1.5%	932
Floridablanca	66.2%	12.3%	19.7%	1.4%	0.5%	1551
Fusagasugá	63.8%	13.3%	20.8%	1.5%	0.5%	854
Girardot	49.9%	20.0%	24.4%	4.4%	1.4%	731

Continúa en la siguiente página



ETC/País	A	B	C	D	Omisión y multimarca	N° estudiantes
Girón	62.2%	14.0%	20.1%	2.8%	1.0%	716
Guainía	50.0%	50.0%	0.0%	0.0%	0.0%	2
Guaviare	59.4%	14.1%	22.4%	2.4%	1.6%	495
Huila	58.0%	16.0%	22.8%	2.7%	0.5%	4000
Ibagué	58.3%	15.4%	23.5%	2.1%	0.7%	3313
Ipiales	61.7%	15.0%	21.0%	1.4%	1.0%	725
Itagüí	56.1%	15.2%	24.3%	3.5%	0.9%	1267
Jamundí	47.4%	21.9%	26.0%	3.2%	1.5%	684
La Guajira	48.2%	19.5%	26.1%	4.4%	1.8%	1358
Lorica	44.3%	19.5%	29.9%	5.5%	0.9%	931
Magangué	49.5%	17.4%	27.3%	4.9%	0.8%	751
Magdalena	43.3%	23.3%	26.7%	5.2%	1.5%	3737
Maicao	43.6%	20.4%	29.2%	5.3%	1.5%	850
Malambo	48.7%	21.3%	22.9%	5.9%	1.2%	563
Manizales	61.2%	13.6%	21.6%	3.2%	0.5%	2369
Medellín	58.8%	13.7%	23.8%	2.8%	1.0%	13275
Meta	59.2%	15.2%	21.3%	3.1%	1.2%	2478
Montería	52.5%	17.6%	24.6%	3.8%	1.4%	2840
Mosquera	63.2%	13.5%	20.2%	2.2%	0.9%	771
Nariño	59.8%	15.6%	20.4%	2.4%	1.8%	4306
Neiva	60.2%	15.0%	22.4%	1.8%	0.5%	2436
Norte de Santander	58.5%	15.4%	22.3%	2.8%	0.9%	3660
Palmira	57.9%	15.0%	24.4%	2.0%	0.8%	1677
Pasto	64.7%	13.9%	19.5%	1.4%	0.5%	2706
Pereira	59.9%	13.6%	23.5%	2.3%	0.8%	2789
Piedecuesta	64.7%	13.8%	18.4%	2.2%	0.9%	855
Pitalito	61.2%	14.0%	23.5%	1.0%	0.3%	763
Popayán	61.7%	14.0%	21.5%	1.2%	1.6%	1832
Putumayo	59.0%	17.0%	20.4%	2.7%	1.0%	1989
Quibdó	44.5%	20.0%	26.9%	5.2%	3.3%	878
Quindío	59.0%	12.4%	24.5%	3.5%	0.6%	1688
Riohacha	49.6%	22.4%	23.4%	4.0%	0.6%	958
Rionegro	63.7%	11.6%	21.2%	3.0%	0.5%	830
Risaralda	57.6%	13.8%	25.4%	2.5%	0.8%	1501
Sabaneta	67.6%	10.9%	19.9%	1.3%	0.3%	377
Sahagún	51.6%	22.1%	22.9%	3.0%	0.4%	791
San Andrés	50.8%	17.2%	22.9%	5.9%	3.1%	354
Santa Marta	52.7%	17.9%	24.1%	3.9%	1.4%	2899
Santander	64.1%	13.3%	20.5%	1.6%	0.4%	4612

Continúa en la siguiente página

ETC/País	A	B	C	D	Omisión y multimarca	N° estudiantes
Sincelejo	50.4%	17.9%	27.8%	3.3%	0.6%	2119
Soacha	59.3%	16.2%	21.8%	2.1%	0.6%	3300
Sogamoso	67.1%	11.6%	19.3%	1.8%	0.2%	964
Soledad	55.9%	17.3%	22.9%	2.7%	1.2%	2583
Sucre	45.6%	20.4%	27.1%	5.8%	1.0%	3938
Tolima	54.8%	17.9%	23.5%	2.9%	0.8%	5129
Tuluá	53.8%	17.9%	24.3%	3.3%	0.6%	1315
Tumaco	49.0%	17.1%	28.2%	4.4%	1.4%	872
Tunja	65.9%	11.7%	20.7%	1.3%	0.5%	1175
Turbo	44.2%	21.8%	26.4%	6.3%	1.4%	804
Uribe	39.6%	25.5%	30.2%	4.0%	0.7%	149
Valle del Cauca	50.2%	18.4%	26.8%	3.3%	1.3%	4706
Vallédupar	50.6%	18.3%	26.7%	3.2%	1.2%	2690
Vaupés	25.0%	25.0%	0.0%	0.0%	50.0%	4
Vichada	48.0%	20.5%	25.8%	2.2%	3.5%	229
Villavicencio	63.7%	13.6%	20.1%	2.1%	0.5%	3070
Yopal	62.4%	14.6%	21.0%	1.5%	0.5%	988
Yumbo	53.1%	18.2%	25.4%	2.4%	0.9%	737
Zipaquirá	66.4%	12.6%	19.5%	1.1%	0.5%	852
Colombia	57.4%	15.4%	23.0%	2.8%	1.3%	275336

*Es posible que los porcentajes mostrados no sumen exactamente 100 debido a aproximaciones decimales.

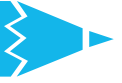

- **Pregunta 8.**

Jaime lanzó 16 veces y terminó sin pérdidas ni ganancias. ¿Cuántos aciertos tuvo Jaime?

- A. 0
- B. 4
- C. 6
- D. 8

- **Estructura**

Competencia	Planteamiento y resolución de problemas
Componente	Numérico - variacional
Afirmación	Resolver problemas en situaciones de variación con funciones polinómicas y exponenciales en contextos aritméticos y geométricos.
Nivel de desempeño	Avanzado
Respuesta Correcta	B

• Resultados a nivel nacional y de Entidad Territorial Certificada (ETC)

ETC/País	A	B	C	D	Omisión y multimarca	N° estudiantes
Amazonas	31.0%	21.2%	13.4%	32.4%	2.0%	410
Antioquia	25.1%	31.9%	11.4%	30.5%	1.1%	13193
Apartadó	23.7%	30.3%	14.0%	30.7%	1.3%	779
Arauca	19.9%	38.4%	12.7%	28.0%	1.0%	1241
Armenia	20.1%	38.9%	12.6%	27.8%	0.6%	1844
Atlántico	30.7%	24.9%	11.2%	31.9%	1.4%	3381
Barrancabermeja	23.7%	36.8%	11.2%	27.2%	1.1%	1305
Barranquilla	25.7%	32.8%	11.5%	28.5%	1.4%	6498
Bello	22.8%	35.4%	12.2%	28.3%	1.3%	2368
Bogotá, D.C.	18.2%	42.4%	10.6%	25.9%	2.9%	46578
Bolívar	31.3%	23.9%	12.8%	30.5%	1.5%	5376
Boyacá	20.5%	38.6%	11.8%	28.3%	0.7%	5619
Bucaramanga	16.6%	50.0%	9.6%	23.2%	0.6%	3739
Buenaventura	34.6%	24.3%	11.4%	27.5%	2.2%	1742
Buga	21.6%	34.0%	12.9%	27.9%	3.6%	635
Caldas	23.6%	31.6%	12.3%	31.9%	0.6%	3338
Cali	24.5%	34.8%	11.2%	27.5%	2.0%	12349
Caquetá	22.0%	34.4%	12.3%	29.9%	1.4%	1128
Cartagena	31.0%	28.1%	11.5%	27.8%	1.6%	6516
Cartago	27.3%	33.2%	10.9%	27.3%	1.3%	608
Casanare	22.3%	36.1%	12.7%	28.3%	0.7%	1433
Cauca	29.7%	26.8%	9.9%	32.1%	1.5%	5696
Cesar	26.7%	28.6%	12.0%	31.6%	1.0%	3686
Chocó	38.2%	18.6%	10.0%	30.8%	2.3%	1417
Chía	15.2%	45.8%	14.7%	23.6%	0.6%	971
Ciénaga	30.0%	27.3%	12.2%	29.5%	1.1%	747
Cundinamarca	20.3%	38.7%	11.3%	29.0%	0.8%	9588
Córdoba	28.0%	24.3%	11.8%	34.5%	1.4%	6073
Cúcuta	22.5%	39.6%	11.5%	25.6%	0.8%	4355
Dosquebradas	23.3%	39.2%	11.5%	24.8%	1.2%	931
Duitama	13.6%	54.5%	10.0%	21.5%	0.5%	951
Envigado	18.8%	50.5%	9.1%	20.7%	0.9%	1332
Facatativá	19.8%	39.1%	14.3%	26.4%	0.4%	791
Florencia	25.0%	34.4%	11.9%	27.8%	0.9%	932
Floridablanca	18.1%	48.3%	9.2%	23.4%	1.1%	1551
Fusagasugá	17.4%	41.3%	11.6%	28.5%	1.2%	854
Girardot	27.9%	30.8%	11.5%	28.0%	1.8%	731

Continúa en la siguiente página



ETC/País	A	B	C	D	Omisión y multimarca	N° estudiantes
Girón	18.9%	41.2%	14.4%	24.4%	1.1%	716
Guainía	50.0%	0.0%	0.0%	50.0%	0.0%	2
Guaviare	23.8%	30.3%	10.5%	33.9%	1.4%	495
Huila	23.6%	32.7%	11.7%	31.2%	0.8%	4000
Ibagué	21.7%	37.9%	11.3%	28.1%	1.0%	3313
Ipiales	19.0%	39.3%	11.7%	28.1%	1.8%	725
Itagüí	21.4%	37.0%	12.9%	27.6%	1.1%	1267
Jamundí	28.1%	29.1%	11.0%	31.1%	0.7%	684
La Guajira	30.9%	24.8%	11.9%	30.9%	1.6%	1358
Lorica	28.9%	22.0%	13.3%	35.3%	0.4%	931
Magangué	29.4%	26.5%	8.8%	34.1%	1.2%	751
Magdalena	32.4%	23.2%	11.2%	31.4%	1.7%	3737
Maicao	26.2%	25.9%	15.3%	30.2%	2.4%	850
Malambo	27.2%	28.4%	15.5%	28.1%	0.9%	563
Manizales	22.2%	37.7%	13.6%	25.5%	1.0%	2369
Medellín	22.6%	35.9%	12.3%	27.9%	1.3%	13275
Meta	21.6%	33.4%	12.8%	30.8%	1.4%	2478
Montería	22.2%	30.6%	12.5%	33.0%	1.7%	2840
Mosquera	20.2%	38.3%	11.8%	29.1%	0.6%	771
Nariño	22.5%	35.1%	9.6%	30.6%	2.2%	4306
Neiva	22.8%	38.5%	10.5%	27.5%	0.7%	2436
Norte de Santander	23.7%	37.0%	11.0%	27.2%	1.1%	3660
Palmira	25.4%	37.0%	10.3%	26.3%	1.0%	1677
Pasto	18.7%	41.8%	9.3%	29.4%	0.8%	2706
Pereira	23.1%	38.3%	10.8%	26.6%	1.2%	2789
Piedecuesta	19.4%	43.4%	10.1%	24.9%	2.2%	855
Pitalito	22.0%	36.7%	10.0%	30.8%	0.5%	763
Popayán	23.3%	35.5%	9.7%	29.6%	1.9%	1832
Putumayo	23.1%	33.0%	10.6%	32.0%	1.3%	1989
Quibdó	33.7%	26.0%	10.7%	25.5%	4.1%	878
Quindío	21.2%	35.5%	13.3%	29.2%	0.8%	1688
Riohacha	29.4%	26.7%	13.9%	29.0%	0.9%	958
Rionegro	17.8%	44.2%	12.5%	24.7%	0.7%	830
Risaralda	27.4%	29.6%	11.4%	31.0%	0.5%	1501
Sabaneta	19.6%	45.1%	11.4%	23.1%	0.8%	377
Sahagún	23.5%	26.8%	12.8%	36.2%	0.8%	791
San Andrés	32.8%	29.1%	7.3%	26.6%	4.2%	354
Santa Marta	26.6%	28.6%	12.7%	30.6%	1.5%	2899
Santander	20.3%	40.7%	10.8%	27.7%	0.6%	4612

Continúa en la siguiente página

ETC/País	A	B	C	D	Omisión y multimarca	N° estudiantes
Sincelejo	25.0%	31.5%	12.3%	30.3%	0.9%	2119
Soacha	22.4%	38.0%	12.5%	26.2%	0.9%	3300
Sogamoso	16.9%	44.6%	11.5%	26.3%	0.6%	964
Soledad	24.2%	33.1%	11.8%	29.4%	1.5%	2583
Sucre	29.1%	24.2%	12.4%	33.2%	1.2%	3938
Tolima	26.3%	29.6%	12.4%	30.5%	1.1%	5129
Tuluá	26.8%	31.5%	11.5%	29.4%	0.9%	1315
Tumaco	34.2%	22.2%	8.9%	32.6%	2.1%	872
Tunja	18.9%	43.7%	11.1%	25.3%	1.0%	1175
Turbo	32.1%	19.8%	12.8%	33.2%	2.1%	804
Uribe	39.6%	30.9%	12.8%	16.1%	0.7%	149
Valle del Cauca	27.0%	29.3%	11.3%	30.7%	1.7%	4706
Valledupar	28.1%	27.7%	11.2%	31.4%	1.5%	2690
Vaupés	25.0%	0.0%	0.0%	25.0%	50.0%	4
Vichada	28.4%	25.8%	14.4%	28.8%	2.6%	229
Villavicencio	19.6%	43.3%	10.8%	25.7%	0.7%	3070
Yopal	18.6%	40.2%	14.1%	26.0%	1.1%	988
Yumbo	22.4%	33.0%	12.8%	30.7%	1.2%	737
Zipaquirá	18.3%	44.6%	12.0%	24.6%	0.5%	852
Colombia	23.4%	35.1%	11.4%	28.5%	1.5%	275336

*Es posible que los porcentajes mostrados no sumen exactamente 100 debido a aproximaciones decimales.

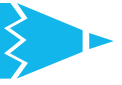

- **Pregunta 9.**

En un mapa, la distancia entre dos pueblos es 16 centímetros. La distancia real entre estos dos pueblos es de 48 kilómetros. ¿Cuántos kilómetros representa cada centímetro del mapa?

- A. $1/4$
- B. $1/3$
- C. 3
- D. 4

- **Estructura**

Competencia	Comunicación, representación y modelación
Componente	Geométrico - métrico
Afirmación	Identificar relaciones entre distintas unidades utilizadas para medir cantidades de la misma magnitud y determinar su pertinencia.
Nivel de desempeño	Satisfactorio
Respuesta Correcta	C

• Resultados a nivel nacional y de Entidad Territorial Certificada (ETC)

ETC/País	A	B	C	D	Omisión y multimarca	N° estudiantes
Amazonas	21.5%	21.0%	32.2%	22.9%	2.4%	410
Antioquia	18.4%	21.7%	43.1%	15.7%	1.0%	13193
Apartadó	25.2%	23.6%	34.5%	15.9%	0.8%	779
Arauca	17.4%	19.5%	49.5%	13.0%	0.6%	1241
Armenia	17.0%	21.0%	46.7%	14.5%	0.7%	1844
Atlántico	24.6%	23.4%	34.2%	16.7%	1.1%	3381
Barrancabermeja	21.8%	20.6%	44.1%	12.7%	0.8%	1305
Barranquilla	18.8%	21.0%	45.7%	13.1%	1.3%	6498
Bello	17.9%	21.2%	45.9%	14.1%	0.9%	2368
Bogotá, D.C.	13.3%	18.3%	53.4%	12.1%	2.9%	46578
Bolívar	22.9%	23.5%	34.8%	17.4%	1.4%	5376
Boyacá	13.7%	19.7%	53.2%	13.0%	0.5%	5619
Bucaramanga	11.7%	16.4%	59.8%	11.3%	0.7%	3739
Buenaventura	23.8%	22.2%	35.0%	16.9%	2.1%	1742
Buga	15.1%	22.0%	46.1%	13.5%	3.1%	635
Caldas	17.2%	20.5%	44.8%	17.1%	0.4%	3338
Cali	16.3%	20.4%	47.1%	13.9%	2.2%	12349
Caquetá	16.9%	18.6%	49.4%	14.3%	0.8%	1128
Cartagena	22.2%	22.9%	39.2%	14.1%	1.6%	6516
Cartago	17.3%	20.9%	45.1%	15.6%	1.2%	608
Casanare	13.8%	19.8%	51.7%	13.8%	0.8%	1433
Cauca	17.6%	19.5%	42.6%	19.0%	1.3%	5696
Cesar	19.8%	21.5%	41.2%	16.8%	0.8%	3686
Chocó	23.9%	24.3%	27.9%	22.1%	1.8%	1417
Chía	11.2%	17.0%	60.1%	10.8%	0.8%	971
Ciénaga	22.9%	25.7%	35.3%	15.0%	1.1%	747
Cundinamarca	14.2%	18.7%	52.5%	13.7%	0.9%	9588
Córdoba	23.1%	23.3%	35.5%	17.2%	0.8%	6073
Cúcuta	16.1%	19.9%	49.9%	13.2%	0.8%	4355
Dosquebradas	14.4%	19.2%	51.9%	13.4%	1.1%	931
Duitama	9.7%	18.0%	60.8%	10.7%	0.8%	951
Envigado	14.0%	18.1%	56.7%	10.1%	1.2%	1332
Facatativá	13.9%	19.7%	54.2%	11.9%	0.3%	791
Florencia	16.8%	20.1%	49.0%	13.2%	0.9%	932
Floridablanca	12.4%	19.2%	56.0%	11.3%	1.1%	1551
Fusagasugá	14.5%	17.1%	55.0%	13.0%	0.4%	854
Girardot	19.8%	23.4%	40.2%	14.8%	1.8%	731

Continúa en la siguiente página



ETC/País	A	B	C	D	Omisión y multimarca	N° estudiantes
Girón	15.1%	19.6%	51.8%	12.3%	1.3%	716
Guainía	50.0%	0.0%	50.0%	0.0%	0.0%	2
Guaviare	11.5%	22.4%	50.7%	13.3%	2.0%	495
Huila	16.0%	20.5%	48.2%	14.9%	0.4%	4000
Ibagué	16.3%	19.9%	48.9%	13.8%	1.1%	3313
Ipiales	9.5%	16.4%	59.2%	13.1%	1.8%	725
Itagüí	19.7%	21.2%	43.6%	14.5%	0.9%	1267
Jamundí	18.9%	21.1%	41.2%	18.3%	0.6%	684
La Guajira	21.3%	22.6%	35.9%	18.5%	1.8%	1358
Lorica	21.9%	27.1%	31.1%	18.7%	1.2%	931
Magangué	22.4%	24.5%	36.6%	14.9%	1.6%	751
Magdalena	24.4%	23.5%	32.4%	18.4%	1.3%	3737
Maicao	25.1%	23.6%	34.0%	15.6%	1.6%	850
Malambo	23.3%	19.7%	38.9%	17.1%	1.1%	563
Manizales	17.1%	19.7%	48.4%	14.3%	0.5%	2369
Medellín	19.0%	21.1%	44.5%	14.1%	1.2%	13275
Meta	14.4%	19.9%	50.8%	13.5%	1.3%	2478
Montería	20.7%	21.6%	41.7%	14.3%	1.7%	2840
Mosquera	14.3%	17.1%	53.7%	14.0%	0.9%	771
Nariño	13.2%	16.7%	52.6%	15.5%	2.0%	4306
Neiva	14.8%	19.3%	52.8%	12.5%	0.6%	2436
Norte de Santander	16.4%	19.3%	50.1%	13.3%	0.9%	3660
Palmira	14.8%	18.2%	51.8%	13.7%	1.5%	1677
Pasto	12.6%	16.9%	55.6%	14.0%	0.8%	2706
Pereira	15.0%	20.7%	48.6%	14.8%	0.9%	2789
Piedecuesta	15.0%	17.8%	53.7%	12.4%	1.2%	855
Pitalito	14.4%	16.9%	54.5%	13.6%	0.5%	763
Popayán	13.0%	16.3%	56.5%	12.6%	1.7%	1832
Putumayo	13.3%	19.1%	50.5%	15.8%	1.3%	1989
Quibdó	25.5%	26.3%	27.0%	18.3%	2.8%	878
Quindío	17.4%	22.2%	43.8%	15.8%	0.8%	1688
Riohacha	24.4%	21.2%	37.5%	16.1%	0.8%	958
Rionegro	18.3%	21.0%	47.5%	11.9%	1.3%	830
Risaralda	15.9%	19.4%	48.1%	16.0%	0.6%	1501
Sabaneta	14.3%	18.3%	50.4%	16.4%	0.5%	377
Sahagún	21.1%	24.1%	40.3%	13.9%	0.5%	791
San Andrés	21.5%	23.7%	33.1%	18.9%	2.8%	354
Santa Marta	19.1%	21.7%	42.3%	15.8%	1.1%	2899
Santander	13.3%	17.2%	54.7%	14.2%	0.6%	4612

Continúa en la siguiente página

ETC/País	A	B	C	D	Omisión y multimarca	N° estudiantes
Sincelejo	20.6%	21.3%	42.0%	15.4%	0.7%	2119
Soacha	16.3%	20.3%	49.4%	13.2%	0.9%	3300
Sogamoso	10.1%	19.6%	58.1%	12.0%	0.2%	964
Soledad	19.6%	20.9%	44.4%	13.8%	1.2%	2583
Sucre	22.6%	23.0%	35.0%	18.5%	0.9%	3938
Tolima	16.7%	21.0%	43.9%	17.5%	0.9%	5129
Tuluá	19.2%	20.9%	43.0%	16.3%	0.7%	1315
Tumaco	23.7%	22.1%	35.3%	17.3%	1.5%	872
Tunja	12.3%	19.1%	54.8%	12.9%	0.9%	1175
Turbo	25.5%	24.8%	31.2%	17.5%	1.0%	804
Uribe	28.2%	34.9%	18.8%	18.1%	0.0%	149
Valle del Cauca	18.1%	21.8%	42.8%	16.0%	1.3%	4706
Valledupar	21.1%	22.5%	39.9%	15.4%	1.2%	2690
Vaupés	0.0%	0.0%	50.0%	0.0%	50.0%	4
Vichada	24.0%	18.8%	39.3%	15.7%	2.2%	229
Villavicencio	13.0%	18.6%	55.6%	12.1%	0.7%	3070
Yopal	13.9%	19.2%	54.0%	12.2%	0.6%	988
Yumbo	19.9%	19.9%	44.1%	14.4%	1.6%	737
Zipaquirá	12.6%	17.0%	57.9%	12.0%	0.6%	852
Colombia	16.9%	20.2%	47.0%	14.4%	1.4%	275336

*Es posible que los porcentajes mostrados no sumen exactamente 100 debido a aproximaciones decimales.



Responde las preguntas 10, 11 y 12 de acuerdo con la siguiente información:

Observa las figuras 1, 2, 3 y 4 que están ubicadas en el plano cartesiano.

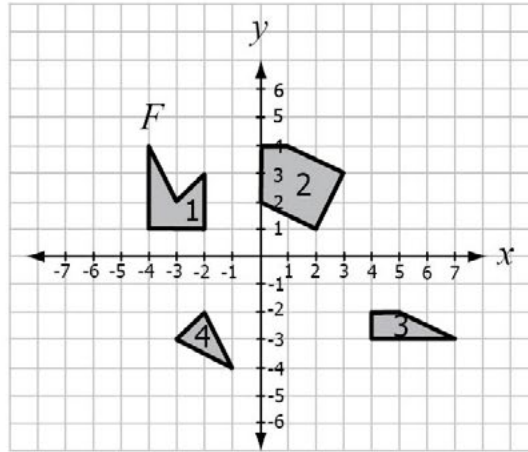

• **Pregunta 10.**

Luego de aplicar dos traslaciones a la figura 2, ésta quedó ubicada en la posición que se observa a continuación.

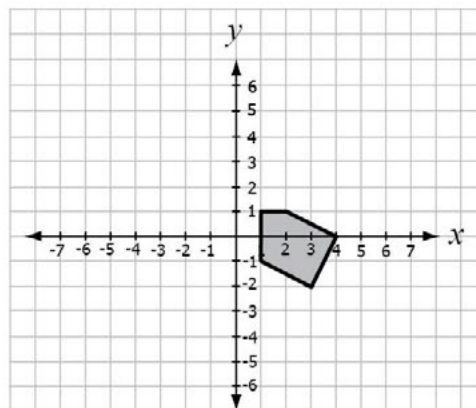

La figura 2 fue trasladada

- A. 1 unidad hacia la derecha y 1 unidad hacia abajo.
- B. 1 unidad hacia la derecha y 3 unidades hacia abajo.
- C. 1 unidad hacia la izquierda y 3 unidades hacia abajo.
- D. 4 unidades hacia la derecha y 2 unidades hacia abajo.

• Estructura

Competencia	Comunicación, representación y modelación
Componente	Geométrico - métrico
Afirmación	Identificar y describir efectos de transformaciones aplicadas a figuras planas.
Nivel de desempeño	Satisfactorio
Respuesta Correcta	B

• Resultados a nivel nacional y de Entidad Territorial Certificada (ETC)

ETC/País	A	B	C	D	Omisión y multimarca	N° estudiantes
Amazonas	19.8%	37.8%	17.1%	23.7%	1.7%	410
Antioquia	19.2%	51.4%	14.2%	14.4%	0.8%	13193
Apartadó	19.9%	45.2%	18.2%	16.0%	0.6%	779
Arauca	18.6%	54.6%	12.6%	13.6%	0.6%	1241
Armenia	16.8%	60.4%	12.8%	9.8%	0.2%	1844
Atlántico	21.1%	43.2%	16.6%	18.5%	0.6%	3381
Barrancabermeja	19.2%	54.3%	13.8%	12.0%	0.6%	1305
Barranquilla	20.2%	51.0%	14.0%	14.0%	0.8%	6498
Bello	16.9%	58.1%	13.8%	10.8%	0.4%	2368
Bogotá, D.C.	13.4%	67.5%	10.1%	6.5%	2.4%	46578
Bolívar	23.8%	37.7%	17.1%	20.4%	1.0%	5376
Boyacá	18.5%	58.4%	12.0%	10.7%	0.4%	5619
Bucaramanga	12.9%	68.9%	10.1%	7.9%	0.2%	3739
Buenaventura	24.2%	40.1%	15.9%	17.9%	2.0%	1742
Buga	15.3%	55.6%	15.6%	11.0%	2.5%	635
Caldas	19.2%	54.5%	12.7%	13.2%	0.3%	3338
Cali	16.4%	58.3%	12.6%	11.3%	1.4%	12349
Caquetá	20.7%	45.8%	12.9%	19.8%	0.8%	1128
Cartagena	21.7%	46.5%	15.7%	15.2%	0.9%	6516
Cartago	15.5%	59.9%	11.0%	12.7%	1.0%	608
Casanare	17.0%	56.0%	12.7%	14.0%	0.3%	1433
Cauca	20.5%	45.3%	13.2%	20.0%	0.9%	5696
Cesar	21.2%	44.7%	14.9%	18.7%	0.5%	3686
Chocó	22.6%	33.5%	19.2%	23.1%	1.6%	1417
Chía	14.0%	70.0%	8.7%	7.1%	0.2%	971
Ciénaga	23.0%	42.2%	16.7%	17.3%	0.8%	747

Continúa en la siguiente página



ETC/País	A	B	C	D	Omisión y multimarca	N° estudiantes
Cundinamarca	16.4%	62.6%	11.1%	9.4%	0.5%	9588
Córdoba	23.6%	38.0%	15.8%	21.8%	0.8%	6073
Cúcuta	17.5%	57.2%	12.5%	12.4%	0.4%	4355
Dosquebradas	16.4%	61.5%	12.8%	8.6%	0.6%	931
Duitama	11.5%	72.0%	11.1%	4.9%	0.4%	951
Envigado	11.2%	72.5%	9.0%	6.7%	0.6%	1332
Facatativá	15.5%	62.6%	13.5%	8.1%	0.3%	791
Florencia	17.5%	54.5%	13.9%	13.5%	0.5%	932
Floridablanca	13.5%	67.8%	10.8%	7.4%	0.5%	1551
Fusagasugá	13.2%	64.9%	11.6%	10.0%	0.4%	854
Girardot	21.2%	51.2%	14.1%	12.4%	1.1%	731
Girón	16.3%	60.8%	13.0%	9.1%	0.8%	716
Guainía	0.0%	50.0%	0.0%	50.0%	0.0%	2
Guaviare	19.4%	45.9%	12.7%	20.4%	1.6%	495
Huila	19.9%	52.5%	11.7%	15.7%	0.2%	4000
Ibagué	17.4%	60.1%	11.9%	10.2%	0.5%	3313
Ipiales	15.9%	61.9%	9.9%	11.2%	1.1%	725
Itagüí	17.0%	59.3%	12.9%	9.8%	1.0%	1267
Jamundí	19.0%	46.6%	15.6%	18.3%	0.4%	684
La Guajira	21.4%	41.5%	17.0%	18.6%	1.5%	1358
Lorica	25.3%	37.2%	17.8%	18.8%	0.9%	931
Magangué	23.7%	39.7%	16.0%	19.8%	0.8%	751
Magdalena	21.6%	37.5%	17.3%	22.6%	1.0%	3737
Maicao	23.9%	38.8%	16.7%	19.4%	1.2%	850
Malambo	21.5%	40.0%	20.1%	17.8%	0.7%	563
Manizales	14.3%	62.3%	12.9%	10.2%	0.3%	2369
Medellín	15.9%	60.0%	13.5%	9.9%	0.8%	13275
Meta	17.2%	54.6%	12.2%	15.0%	1.0%	2478
Montería	20.2%	47.5%	13.8%	17.3%	1.3%	2840
Mosquera	13.5%	68.1%	11.0%	7.3%	0.1%	771
Nariño	17.6%	52.1%	12.1%	16.6%	1.6%	4306
Neiva	17.1%	59.9%	10.5%	12.4%	0.1%	2436
Norte de Santander	20.4%	51.6%	12.9%	14.4%	0.6%	3660
Palmira	14.7%	59.0%	13.2%	12.2%	0.9%	1677
Pasto	13.5%	63.7%	11.9%	10.6%	0.3%	2706
Pereira	15.5%	62.4%	11.2%	10.3%	0.6%	2789
Piedecuesta	14.7%	65.3%	10.6%	8.7%	0.7%	855
Pitalito	19.1%	58.8%	11.4%	10.5%	0.1%	763
Popayán	16.6%	61.2%	10.8%	10.2%	1.3%	1832

Continúa en la siguiente página

ETC/País	A	B	C	D	Omisión y multimarca	N° estudiantes
Putumayo	17.7%	53.1%	12.7%	15.8%	0.7%	1989
Quibdó	18.2%	38.5%	16.1%	24.3%	3.0%	878
Quindío	16.0%	57.6%	13.9%	12.1%	0.3%	1688
Riohacha	23.0%	41.4%	17.6%	17.2%	0.7%	958
Rionegro	14.6%	63.9%	11.1%	9.9%	0.6%	830
Risaralda	19.0%	55.4%	13.0%	12.3%	0.4%	1501
Sabaneta	14.1%	69.8%	8.5%	6.9%	0.8%	377
Sahagún	22.9%	40.7%	15.8%	20.0%	0.6%	791
San Andrés	22.9%	43.5%	15.3%	16.1%	2.3%	354
Santa Marta	20.1%	48.5%	15.7%	14.9%	0.9%	2899
Santander	17.6%	59.8%	10.7%	11.4%	0.4%	4612
Sincelejo	20.7%	50.3%	14.3%	14.1%	0.5%	2119
Soacha	16.0%	61.3%	13.1%	9.2%	0.3%	3300
Sogamoso	14.0%	69.7%	8.9%	7.2%	0.2%	964
Soledad	19.7%	49.1%	15.4%	15.2%	0.6%	2583
Sucre	22.6%	40.8%	16.0%	20.0%	0.6%	3938
Tolima	18.9%	49.2%	13.7%	17.6%	0.6%	5129
Tuluá	15.7%	57.0%	11.9%	14.8%	0.6%	1315
Tumaco	17.8%	40.8%	15.8%	24.3%	1.3%	872
Tunja	14.2%	68.5%	11.1%	5.9%	0.3%	1175
Turbo	23.8%	33.7%	18.9%	22.8%	0.9%	804
Uribia	22.1%	37.6%	12.8%	27.5%	0.0%	149
Valle del Cauca	19.1%	50.2%	14.1%	15.6%	0.9%	4706
Valledupar	23.6%	44.9%	13.5%	17.1%	0.9%	2690
Vaupés	0.0%	25.0%	0.0%	25.0%	50.0%	4
Vichada	22.3%	42.4%	14.8%	18.8%	1.7%	229
Villavicencio	16.3%	61.3%	12.0%	10.1%	0.4%	3070
Yopal	16.7%	61.7%	10.3%	11.0%	0.2%	988
Yumbo	17.1%	54.8%	13.4%	14.0%	0.7%	737
Zipaquirá	14.0%	69.1%	10.6%	6.2%	0.1%	852
Colombia	17.6%	55.8%	12.9%	12.7%	1.0%	275336

*Es posible que los porcentajes mostrados no sumen exactamente 100 debido a aproximaciones decimales.

• **Pregunta 11.**

La figura 1 se rota 180° en sentido contrario al movimiento de las manecillas del reloj, teniendo como punto fijo a F . ¿Cuál es la posición de la figura 1 luego de la rotación?

A.

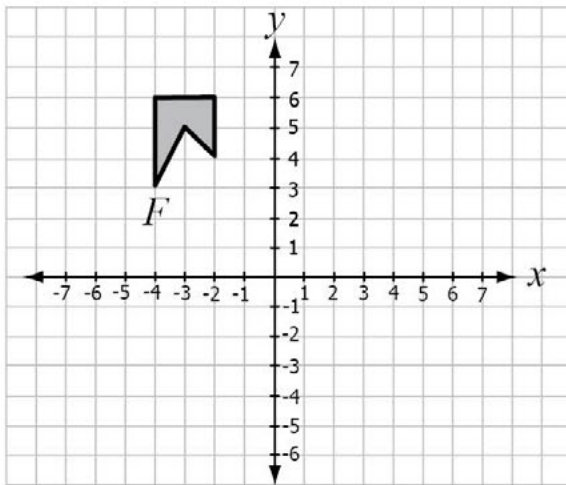

B.

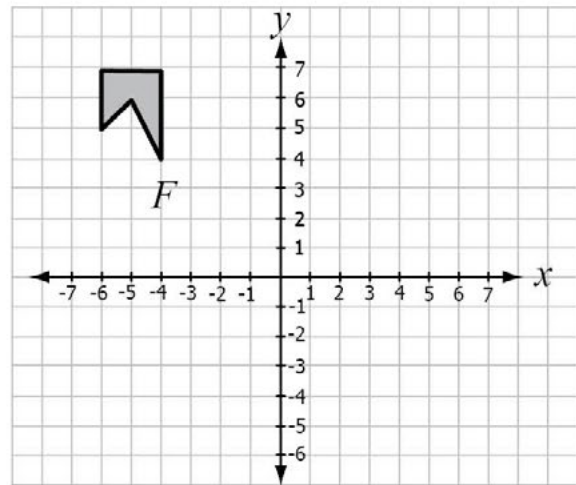

C.

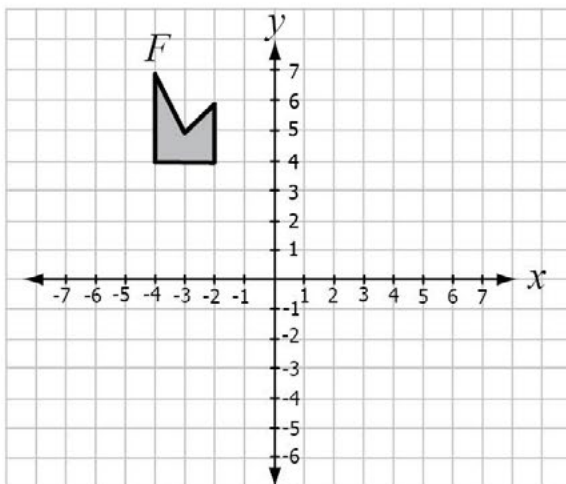

D.

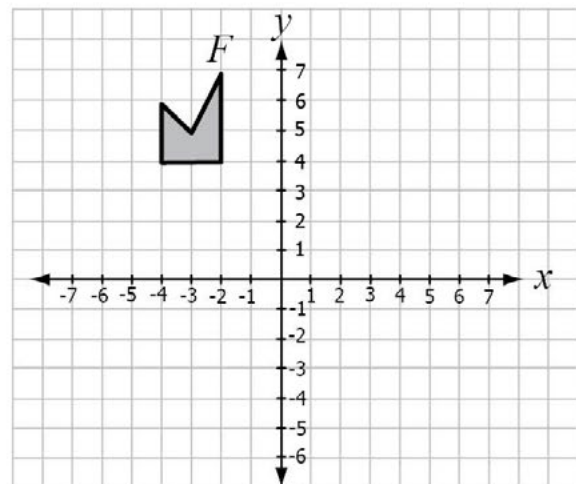

• Estructura

Competencia	Comunicación, representación y modelación
Componente	Geométrico - métrico
Afirmación	Identificar y describir efectos de transformaciones aplicadas a figuras planas.
Nivel de desempeño	Satisfactorio
Respuesta Correcta	B

• Resultados a nivel nacional y de Entidad Territorial Certificada (ETC)

ETC/País	A	B	C	D	Omisión y multimarca	N° estudiantes
Amazonas	18.5%	35.9%	24.4%	19.5%	1.7%	410
Antioquia	22.9%	38.5%	20.9%	16.8%	0.9%	13193
Apartadó	21.7%	36.7%	22.0%	18.9%	0.8%	779
Arauca	22.4%	44.0%	18.4%	14.5%	0.7%	1241
Armenia	23.7%	43.5%	18.5%	13.9%	0.3%	1844
Atlántico	21.4%	34.5%	24.8%	18.4%	0.8%	3381
Barrancabermeja	19.2%	43.9%	20.8%	15.3%	0.8%	1305
Barranquilla	23.0%	41.4%	19.0%	15.6%	1.0%	6498
Bello	24.1%	43.9%	16.4%	14.8%	0.8%	2368
Bogotá, D.C.	21.8%	47.9%	14.6%	13.1%	2.5%	46578
Bolívar	20.7%	32.1%	27.5%	18.1%	1.6%	5376
Boyacá	21.7%	43.3%	18.6%	15.9%	0.5%	5619
Bucaramanga	22.2%	50.5%	14.5%	12.4%	0.4%	3739
Buenaventura	17.9%	33.0%	27.5%	19.8%	1.9%	1742
Buga	19.4%	43.9%	22.4%	11.5%	2.8%	635
Caldas	23.2%	37.6%	21.7%	17.2%	0.4%	3338
Cali	21.9%	43.0%	18.2%	15.2%	1.7%	12349
Caquetá	18.7%	38.2%	23.7%	18.6%	0.8%	1128
Cartagena	20.5%	38.4%	23.6%	16.2%	1.4%	6516
Cartago	23.7%	43.4%	16.3%	15.5%	1.2%	608
Casanare	21.1%	42.1%	20.2%	15.8%	0.7%	1433
Cauca	20.1%	34.9%	23.8%	19.7%	1.4%	5696
Cesar	22.2%	34.6%	23.3%	19.3%	0.6%	3686
Chocó	20.1%	28.3%	28.7%	20.3%	2.5%	1417
Chía	21.3%	52.8%	11.6%	13.7%	0.5%	971
Ciénaga	18.7%	33.5%	26.9%	19.5%	1.3%	747

Continúa en la siguiente página



ETC/País	A	B	C	D	Omisión y multimarca	N° estudiantes
Cundinamarca	21.1%	45.2%	17.3%	15.8%	0.6%	9588
Córdoba	20.5%	33.4%	26.4%	18.8%	1.0%	6073
Cúcuta	22.4%	44.7%	18.3%	14.1%	0.5%	4355
Dosquebradas	21.4%	45.1%	18.0%	14.5%	1.0%	931
Duitama	20.0%	54.4%	13.8%	11.4%	0.5%	951
Envigado	20.6%	51.3%	14.5%	12.9%	0.8%	1332
Facatativá	23.8%	47.2%	15.2%	13.7%	0.3%	791
Florencia	22.0%	42.0%	19.2%	16.3%	0.5%	932
Floridablanca	23.8%	48.8%	13.7%	12.9%	0.8%	1551
Fusagasugá	22.4%	47.8%	15.0%	14.3%	0.6%	854
Girardot	22.7%	36.8%	21.9%	17.5%	1.1%	731
Girón	23.5%	44.8%	18.7%	12.2%	0.8%	716
Guainía	0.0%	0.0%	100.0%	0.0%	0.0%	2
Guaviare	24.2%	37.0%	21.4%	16.2%	1.2%	495
Huila	22.8%	39.1%	20.4%	17.4%	0.3%	4000
Ibagué	23.0%	43.4%	18.5%	14.6%	0.5%	3313
Ipiales	21.4%	45.0%	17.2%	14.9%	1.5%	725
Itagüí	20.1%	43.4%	18.7%	16.5%	1.3%	1267
Jamundí	22.5%	36.4%	21.1%	19.4%	0.6%	684
La Guajira	21.4%	33.5%	26.2%	17.2%	1.6%	1358
Lorica	19.5%	33.3%	28.9%	17.5%	0.8%	931
Magangué	19.6%	35.6%	25.4%	18.5%	0.9%	751
Magdalena	20.6%	32.0%	26.9%	18.9%	1.6%	3737
Maicao	20.6%	34.7%	27.1%	16.6%	1.1%	850
Malambo	21.3%	37.1%	20.6%	20.1%	0.9%	563
Manizales	23.3%	43.6%	16.9%	15.7%	0.5%	2369
Medellín	22.9%	42.7%	18.1%	15.3%	1.0%	13275
Meta	20.5%	40.0%	20.2%	18.0%	1.4%	2478
Montería	21.5%	37.3%	22.0%	17.6%	1.5%	2840
Mosquera	22.2%	47.0%	17.8%	13.0%	0.1%	771
Nariño	21.0%	40.7%	20.8%	15.7%	1.8%	4306
Neiva	22.0%	46.5%	17.2%	13.9%	0.4%	2436
Norte de Santander	23.5%	41.1%	18.3%	16.2%	0.8%	3660
Palmira	22.2%	47.2%	16.6%	13.4%	0.7%	1677
Pasto	23.5%	44.9%	16.3%	14.7%	0.6%	2706
Pereira	23.1%	44.0%	17.1%	15.0%	0.8%	2789
Piedecuesta	23.7%	43.2%	16.0%	16.0%	1.1%	855
Pitalito	21.2%	45.2%	19.8%	13.5%	0.3%	763
Popayán	21.7%	44.7%	16.2%	16.2%	1.4%	1832

Continúa en la siguiente página

ETC/País	A	B	C	D	Omisión y multimarca	N° estudiantes
Putumayo	22.0%	39.5%	21.3%	16.3%	0.9%	1989
Quibdó	21.3%	32.0%	25.2%	18.7%	2.8%	878
Quindío	23.6%	40.9%	18.7%	16.2%	0.5%	1688
Riohacha	25.4%	33.9%	22.3%	17.2%	1.1%	958
Rionegro	21.0%	51.0%	13.4%	14.1%	0.6%	830
Risaralda	23.9%	39.6%	21.7%	14.3%	0.6%	1501
Sabaneta	21.2%	50.1%	13.8%	14.3%	0.5%	377
Sahagún	23.8%	32.5%	24.4%	18.8%	0.5%	791
San Andrés	22.3%	34.5%	25.4%	14.1%	3.7%	354
Santa Marta	22.7%	36.3%	22.2%	17.6%	1.1%	2899
Santander	23.2%	44.4%	16.8%	15.2%	0.5%	4612
Sincedejo	20.4%	40.6%	22.3%	15.9%	0.8%	2119
Soacha	24.8%	43.5%	16.6%	14.6%	0.6%	3300
Sogamoso	23.7%	51.7%	13.9%	10.6%	0.2%	964
Soledad	24.7%	38.5%	21.1%	14.8%	0.9%	2583
Sucre	20.0%	34.5%	26.0%	18.5%	1.0%	3938
Tolima	22.3%	37.6%	22.1%	17.3%	0.7%	5129
Tuluá	19.7%	39.3%	22.1%	18.2%	0.7%	1315
Tumaco	20.1%	34.4%	25.3%	18.3%	1.8%	872
Tunja	25.5%	48.3%	14.4%	11.2%	0.6%	1175
Turbo	20.0%	31.2%	28.1%	19.3%	1.4%	804
Uribe	18.1%	31.5%	30.2%	19.5%	0.7%	149
Valle del Cauca	21.1%	38.4%	22.5%	16.9%	1.2%	4706
Valledupar	21.7%	37.5%	21.3%	18.2%	1.2%	2690
Vaupés	0.0%	25.0%	25.0%	0.0%	50.0%	4
Vichada	17.0%	35.4%	25.3%	20.5%	1.7%	229
Villavicencio	24.0%	44.6%	16.4%	14.5%	0.5%	3070
Yopal	22.6%	48.3%	14.4%	14.4%	0.4%	988
Yumbo	21.0%	43.1%	17.8%	16.6%	1.5%	737
Zipaquirá	22.2%	50.9%	14.3%	12.1%	0.5%	852
Colombia	21.9%	41.8%	19.3%	15.7%	1.2%	275336

*Es posible que los porcentajes mostrados no sumen exactamente 100 debido a aproximaciones decimales.

• **Pregunta 12.**

Las figuras 1, 2, 3 y 4 se reflejan respecto al eje y . ¿Cuál de las siguientes ilustraciones muestra las figuras reflejadas?

A.

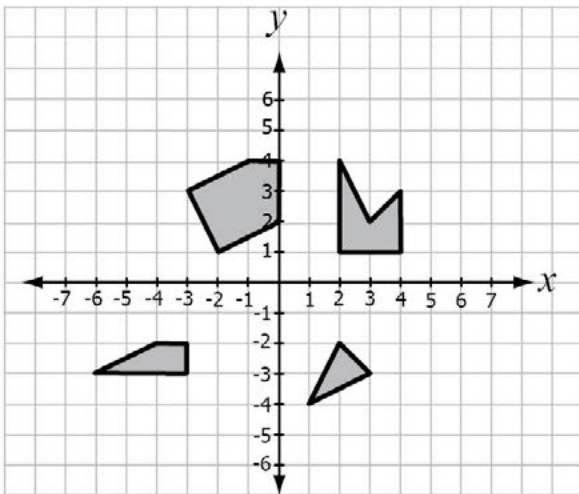

B.

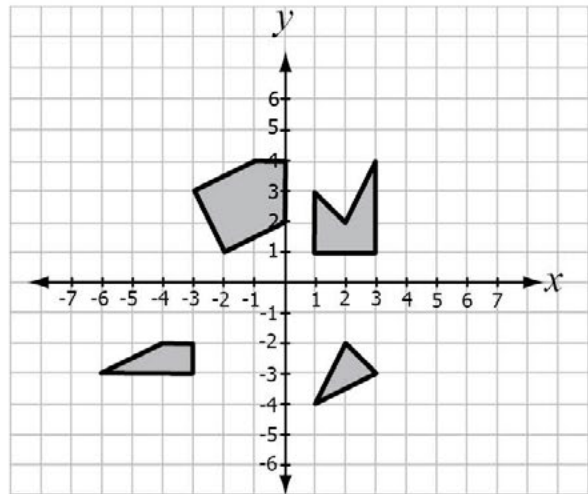

C.

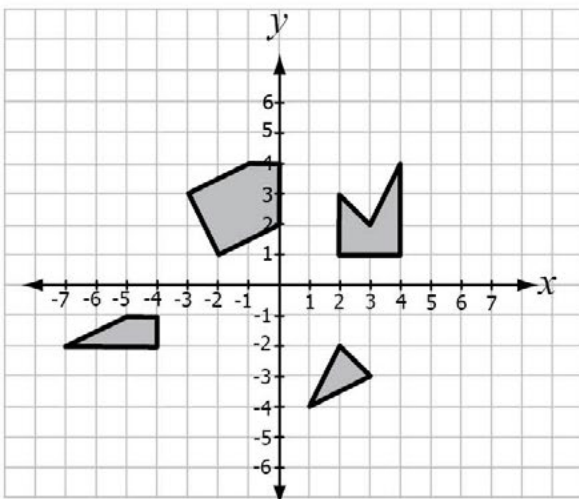

D.

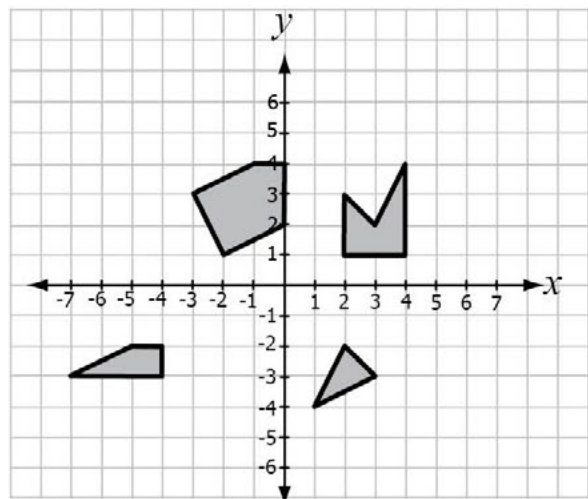

• Estructura

Competencia	Comunicación, representación y modelación
Componente	Geométrico - métrico
Afirmación	Identificar y describir efectos de transformaciones aplicadas a figuras planas.
Nivel de desempeño	Avanzado
Respuesta Correcta	D

• Resultados a nivel nacional y de Entidad Territorial Certificada (ETC)

ETC/País	A	B	C	D	Omisión y multimarca	N° estudiantes
Amazonas	24.6%	25.6%	21.2%	26.1%	2.4%	410
Antioquia	21.9%	23.0%	21.2%	32.3%	1.6%	13193
Apartadó	25.3%	23.9%	21.7%	28.1%	1.0%	779
Arauca	20.2%	22.7%	21.3%	34.3%	1.5%	1241
Armenia	20.8%	21.2%	19.0%	38.2%	0.7%	1844
Atlántico	24.8%	22.4%	19.5%	31.9%	1.3%	3381
Barrancabermeja	23.0%	19.2%	18.9%	37.5%	1.4%	1305
Barranquilla	22.3%	21.7%	18.9%	35.1%	2.0%	6498
Bello	21.2%	19.7%	20.3%	37.0%	1.9%	2368
Bogotá, D.C.	17.3%	17.9%	17.3%	44.3%	3.2%	46578
Bolívar	26.5%	22.6%	22.2%	26.4%	2.3%	5376
Boyacá	21.2%	21.2%	20.5%	36.0%	1.1%	5619
Bucaramanga	18.4%	18.3%	16.7%	45.7%	0.9%	3739
Buenaventura	27.2%	23.8%	21.0%	25.2%	2.8%	1742
Buga	22.0%	17.5%	23.9%	33.4%	3.1%	635
Caldas	21.4%	23.5%	22.2%	32.0%	0.9%	3338
Cali	20.1%	20.0%	19.3%	38.1%	2.5%	12349
Caquetá	23.1%	24.9%	21.7%	28.9%	1.3%	1128
Cartagena	23.2%	22.0%	20.6%	32.3%	2.0%	6516
Cartago	20.2%	22.2%	21.5%	34.2%	1.8%	608
Casanare	23.3%	19.8%	19.7%	35.8%	1.4%	1433
Cauca	23.5%	23.6%	21.6%	29.0%	2.3%	5696
Cesar	24.9%	21.8%	22.2%	29.9%	1.2%	3686
Chocó	28.5%	22.2%	21.6%	24.8%	2.8%	1417
Chía	16.6%	16.2%	18.2%	47.8%	1.2%	971

Continúa en la siguiente página



ETC/País	A	B	C	D	Omisión y multimarca	N° estudiantes
Ciénaga	22.1%	23.7%	21.8%	30.8%	1.6%	747
Cundinamarca	19.6%	20.9%	19.6%	38.8%	1.1%	9588
Córdoba	25.3%	24.1%	22.0%	26.7%	1.8%	6073
Cúcuta	20.4%	19.5%	18.2%	40.7%	1.2%	4355
Dosquebradas	19.7%	20.9%	19.7%	38.0%	1.7%	931
Duitama	16.0%	14.7%	17.6%	51.2%	0.5%	951
Envigado	16.9%	15.3%	16.2%	50.2%	1.4%	1332
Facatativá	19.0%	18.8%	19.3%	42.1%	0.8%	791
Florencia	23.6%	21.6%	21.4%	32.4%	1.1%	932
Floridablanca	19.0%	17.0%	17.3%	45.6%	1.2%	1551
Fusagasugá	18.9%	22.0%	17.6%	40.3%	1.3%	854
Girardot	21.9%	21.3%	21.1%	34.1%	1.6%	731
Girón	21.5%	18.7%	20.3%	38.4%	1.1%	716
Guainía	0.0%	0.0%	0.0%	100.0%	0.0%	2
Guaviare	23.2%	22.8%	19.4%	31.9%	2.6%	495
Huila	20.5%	22.3%	21.1%	35.1%	1.0%	4000
Ibagué	20.8%	20.6%	19.4%	37.9%	1.3%	3313
Ipiales	18.3%	21.4%	17.9%	40.6%	1.8%	725
Itagüí	20.8%	20.8%	21.0%	35.4%	2.0%	1267
Jamundí	23.2%	21.8%	22.8%	30.7%	1.5%	684
La Guajira	26.4%	24.1%	18.4%	29.1%	2.1%	1358
Lorica	26.9%	22.4%	23.1%	25.5%	2.1%	931
Magangué	23.7%	22.9%	21.4%	30.2%	1.7%	751
Magdalena	28.6%	22.5%	21.6%	25.1%	2.2%	3737
Maicao	22.7%	24.0%	22.9%	28.1%	2.2%	850
Malambo	24.0%	20.1%	20.8%	33.7%	1.4%	563
Manizales	19.6%	21.7%	21.0%	36.7%	1.1%	2369
Medellín	20.3%	20.3%	20.2%	37.5%	1.8%	13275
Meta	20.5%	21.6%	22.4%	33.5%	2.1%	2478
Montería	23.0%	22.8%	20.5%	31.4%	2.3%	2840
Mosquera	17.3%	18.8%	20.8%	42.5%	0.6%	771
Nariño	22.9%	22.1%	20.8%	31.7%	2.6%	4306
Neiva	19.2%	20.4%	18.9%	40.5%	1.0%	2436
Norte de Santander	22.5%	21.1%	20.7%	34.3%	1.4%	3660
Palmira	19.7%	19.7%	19.3%	40.1%	1.3%	1677
Pasto	18.0%	19.3%	19.6%	42.3%	0.8%	2706
Pereira	19.5%	21.1%	19.9%	37.8%	1.6%	2789
Piedecuesta	20.6%	18.4%	19.9%	39.9%	1.3%	855
Pitalito	19.9%	22.5%	21.9%	34.6%	1.0%	763

Continúa en la siguiente página

ETC/País	A	B	C	D	Omisión y multimarca	N° estudiantes
Popayán	21.9%	20.6%	19.3%	35.9%	2.3%	1832
Putumayo	21.7%	23.1%	18.6%	34.9%	1.7%	1989
Quibdó	26.0%	21.2%	23.9%	25.3%	3.6%	878
Quindío	22.3%	23.0%	18.8%	34.6%	1.3%	1688
Riohacha	24.5%	21.7%	21.4%	30.0%	2.4%	958
Rionegro	19.3%	19.5%	20.5%	39.3%	1.4%	830
Risaralda	22.7%	21.9%	22.3%	32.3%	0.9%	1501
Sabaneta	17.2%	19.9%	18.0%	43.8%	1.1%	377
Sahagún	21.6%	24.0%	24.8%	28.6%	1.0%	791
San Andrés	24.9%	22.9%	20.3%	28.2%	3.7%	354
Santa Marta	23.7%	23.0%	21.6%	30.3%	1.4%	2899
Santander	20.1%	21.2%	19.7%	37.8%	1.1%	4612
Sincedejo	23.0%	21.7%	22.5%	31.5%	1.3%	2119
Soacha	20.0%	19.7%	19.9%	39.3%	1.1%	3300
Sogamoso	18.6%	18.8%	17.9%	44.4%	0.3%	964
Soledad	21.8%	22.3%	19.9%	34.5%	1.5%	2583
Sucre	25.4%	24.4%	22.7%	26.2%	1.3%	3938
Tolima	23.2%	23.7%	21.2%	30.6%	1.3%	5129
Tuluá	23.5%	21.0%	19.5%	34.1%	1.8%	1315
Tumaco	24.4%	26.0%	21.0%	25.9%	2.6%	872
Tunja	17.1%	17.4%	16.7%	47.7%	1.1%	1175
Turbo	27.4%	23.8%	23.0%	23.5%	2.4%	804
Uribe	32.9%	28.2%	17.4%	21.5%	0.0%	149
Valle del Cauca	21.8%	22.5%	22.1%	31.9%	1.7%	4706
Valledupar	23.6%	22.0%	20.9%	31.9%	1.6%	2690
Vaupés	0.0%	0.0%	25.0%	25.0%	50.0%	4
Vichada	26.2%	25.3%	23.1%	23.1%	2.2%	229
Villavicencio	18.8%	19.8%	19.8%	40.1%	1.5%	3070
Yopal	18.7%	19.3%	18.4%	42.3%	1.2%	988
Yumbo	18.9%	20.6%	21.2%	37.3%	2.0%	737
Zipaquirá	15.3%	17.0%	18.8%	48.5%	0.5%	852
Colombia	21.1%	20.9%	19.9%	36.3%	1.9%	275336

*Es posible que los porcentajes mostrados no sumen exactamente 100 debido a aproximaciones decimales.

• **Pregunta 13.**

En la siguiente gráfica se muestran los resultados de los últimos cinco censos realizados en Colombia respecto a los porcentajes de alfabetismo de mujeres y hombres mayores de 15 años.

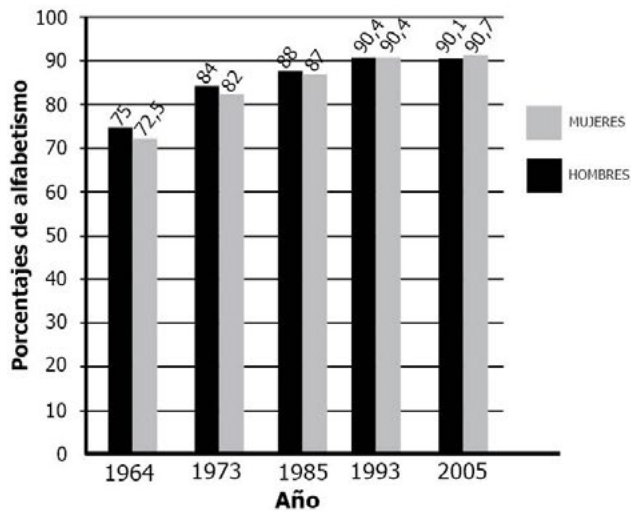

Fuente: DANE (2008)

¿Cuál o cuáles de las siguientes afirmaciones acerca de la gráfica es o son verdadera(s)?

- I. El porcentaje de alfabetismo en el 2005 aumentó respecto al nivel de 1964.
- II. En todos los censos, el porcentaje de alfabetismo en hombres fue mayor que el porcentaje de alfabetismo en mujeres.
- III. En los últimos 4 censos el porcentaje de alfabetismo fue superior a 80 tanto en hombres como en mujeres.

- A. I solamente.
- B. II solamente.
- C. I y III solamente.
- D. II y III solamente.

• Estructura

Competencia	Razonamiento y argumentación
Componente	Aleatorio
Afirmación	Formular inferencias y justificar Razonamiento y argumentaciones y conclusiones a partir del análisis de información estadística
Nivel de desempeño	Satisfactorio
Respuesta Correcta	C

• Resultados a nivel nacional y de Entidad Territorial Certificada (ETC)

ETC/País	A	B	C	D	Omisión y multimarca	N° estudiantes
Amazonas	24.6%	16.3%	40.0%	17.6%	1.5%	410
Antioquia	23.5%	11.3%	50.6%	13.9%	0.7%	13193
Apartadó	24.5%	13.1%	45.4%	16.2%	0.8%	779
Arauca	23.1%	12.2%	52.5%	11.8%	0.5%	1241
Armenia	22.6%	9.5%	56.9%	10.7%	0.2%	1844
Atlántico	25.9%	14.6%	42.0%	16.9%	0.7%	3381
Barrancabermeja	18.9%	9.1%	57.4%	14.1%	0.5%	1305
Barranquilla	23.5%	10.2%	52.1%	13.2%	0.9%	6498
Bello	21.9%	8.8%	57.2%	11.7%	0.4%	2368
Bogotá, D.C.	20.0%	6.0%	63.1%	8.4%	2.4%	46578
Bolívar	25.7%	16.5%	39.3%	17.6%	0.9%	5376
Boyacá	21.5%	9.3%	57.0%	11.8%	0.4%	5619
Bucaramanga	19.0%	5.5%	66.9%	8.4%	0.2%	3739
Buenaventura	24.9%	13.5%	43.1%	16.6%	1.9%	1742
Buga	22.8%	10.4%	53.1%	11.2%	2.5%	635
Caldas	26.4%	9.9%	51.3%	12.1%	0.3%	3338
Cali	21.7%	9.3%	56.5%	11.1%	1.4%	12349
Caquetá	24.7%	14.5%	48.2%	11.9%	0.6%	1128
Cartagena	25.0%	12.3%	47.7%	14.3%	0.8%	6516
Cartago	20.9%	8.6%	57.4%	12.0%	1.2%	608
Casanare	24.5%	12.1%	51.8%	11.2%	0.5%	1433
Cauca	25.8%	12.9%	44.6%	15.8%	0.9%	5696
Cesar	25.5%	14.1%	44.1%	15.9%	0.4%	3686
Chocó	25.6%	18.7%	34.9%	19.2%	1.6%	1417
Chía	17.1%	4.9%	70.6%	7.1%	0.2%	971

Continúa en la siguiente página



ETC/País	A	B	C	D	Omisión y multimarca	N° estudiantes
Ciénaga	21.8%	17.1%	41.0%	19.7%	0.4%	747
Cundinamarca	21.9%	7.9%	59.5%	10.1%	0.6%	9588
Córdoba	25.8%	16.1%	39.3%	18.1%	0.8%	6073
Cúcuta	22.2%	9.6%	57.2%	10.8%	0.3%	4355
Dosquebradas	20.3%	6.4%	61.1%	11.3%	0.9%	931
Duitama	16.2%	5.2%	70.3%	7.8%	0.5%	951
Envigado	17.0%	5.6%	68.2%	8.7%	0.5%	1332
Facatativá	20.6%	7.3%	61.3%	10.4%	0.4%	791
Florencia	23.6%	9.9%	53.9%	12.2%	0.4%	932
Floridablanca	18.9%	6.6%	65.8%	8.0%	0.7%	1551
Fusagasugá	21.7%	7.4%	61.5%	9.0%	0.5%	854
Girardot	23.5%	11.6%	48.4%	15.3%	1.1%	731
Girón	19.4%	7.3%	60.2%	12.2%	1.0%	716
Guainía	50.0%	50.0%	0.0%	0.0%	0.0%	2
Guaviare	25.5%	14.9%	43.4%	14.9%	1.2%	495
Huila	24.0%	10.2%	52.9%	12.7%	0.2%	4000
Ibagué	22.0%	8.0%	58.6%	10.8%	0.5%	3313
Ipiales	20.0%	9.7%	58.3%	10.9%	1.1%	725
Itagüí	21.2%	11.6%	55.5%	10.7%	1.1%	1267
Jamundí	24.4%	12.0%	48.2%	14.8%	0.6%	684
La Guajira	25.0%	13.0%	42.8%	17.9%	1.3%	1358
Lorica	26.5%	17.6%	38.1%	17.3%	0.4%	931
Magangué	25.4%	14.2%	43.4%	16.4%	0.5%	751
Magdalena	26.9%	16.5%	36.3%	19.4%	1.0%	3737
Maicao	25.5%	14.9%	42.0%	16.4%	1.2%	850
Malambo	28.8%	15.1%	39.8%	15.8%	0.5%	563
Manizales	22.5%	8.4%	58.2%	10.6%	0.4%	2369
Medellín	21.4%	8.9%	57.9%	11.0%	0.8%	13275
Meta	24.3%	11.1%	51.5%	11.9%	1.1%	2478
Montería	23.5%	11.8%	48.8%	14.6%	1.3%	2840
Mosquera	22.8%	6.4%	60.7%	10.0%	0.1%	771
Nariño	23.8%	8.6%	53.7%	12.1%	1.8%	4306
Neiva	22.2%	8.4%	59.0%	10.1%	0.2%	2436
Norte de Santander	23.6%	10.4%	54.0%	11.4%	0.6%	3660
Palmira	21.2%	7.5%	58.4%	12.2%	0.7%	1677
Pasto	19.1%	6.5%	63.3%	10.6%	0.4%	2706
Pereira	21.0%	8.3%	58.4%	11.6%	0.7%	2789
Piedecuesta	19.2%	8.3%	59.5%	12.2%	0.8%	855
Pitalito	25.4%	10.2%	53.7%	10.6%	0.0%	763

Continúa en la siguiente página

ETC/País	A	B	C	D	Omisión y multimarca	N° estudiantes
Popayán	22.7%	7.6%	56.9%	11.5%	1.3%	1832
Putumayo	24.4%	11.1%	50.3%	13.4%	0.8%	1989
Quibdó	24.5%	13.6%	42.1%	17.1%	2.7%	878
Quindío	22.5%	9.7%	52.8%	14.6%	0.5%	1688
Riohacha	23.8%	14.7%	44.6%	16.2%	0.7%	958
Rionegro	17.3%	6.0%	66.3%	9.8%	0.6%	830
Risaralda	23.5%	9.4%	52.4%	14.5%	0.3%	1501
Sabaneta	17.8%	5.0%	68.2%	9.0%	0.0%	377
Sahagún	25.5%	15.0%	43.6%	15.8%	0.0%	791
San Andrés	25.4%	13.0%	42.4%	16.9%	2.3%	354
Santa Marta	26.1%	13.6%	45.5%	14.0%	0.8%	2899
Santander	21.5%	7.9%	59.1%	11.1%	0.4%	4612
Sincedejo	27.5%	10.0%	48.7%	13.4%	0.4%	2119
Soacha	22.9%	7.8%	58.8%	9.8%	0.6%	3300
Sogamoso	18.9%	6.4%	66.1%	8.5%	0.1%	964
Soledad	25.4%	12.2%	49.5%	12.0%	0.9%	2583
Sucre	24.4%	15.0%	41.7%	18.3%	0.6%	3938
Tolima	24.2%	12.4%	48.0%	14.9%	0.6%	5129
Tuluá	25.7%	10.3%	51.0%	12.5%	0.5%	1315
Tumaco	25.8%	14.2%	39.9%	18.7%	1.4%	872
Tunja	16.9%	5.8%	68.9%	8.1%	0.3%	1175
Turbo	23.8%	16.2%	39.4%	19.5%	1.1%	804
Uribe	24.2%	14.8%	42.3%	18.8%	0.0%	149
Valle del Cauca	23.7%	12.3%	49.5%	13.5%	1.0%	4706
Valledupar	24.1%	11.7%	48.0%	15.5%	0.7%	2690
Vaupés	0.0%	0.0%	25.0%	25.0%	50.0%	4
Vichada	28.4%	8.7%	41.9%	18.8%	2.2%	229
Villavicencio	20.6%	8.4%	59.8%	10.9%	0.3%	3070
Yopal	23.0%	8.1%	58.8%	10.0%	0.1%	988
Yumbo	23.6%	10.7%	52.6%	12.2%	0.8%	737
Zipaquirá	18.0%	4.3%	69.0%	8.5%	0.2%	852
Colombia	22.6%	9.9%	54.3%	12.2%	1.0%	275336

*Es posible que los porcentajes mostrados no sumen exactamente 100 debido a aproximaciones decimales.

 Responde las preguntas 14 y 15 de acuerdo con la siguiente información:

En la siguiente gráfica se muestra la variación del peso de Pedro respecto a su edad. Las regiones sombreadas permiten determinar cuándo ha tenido sobrepeso, peso normal o bajo peso.



Gráfico modificado www.colombiaaprende.edu.co

• **Pregunta 14.**

¿En cuál de las siguientes tablas la información consignada corresponde a la información de la gráfica?

A.

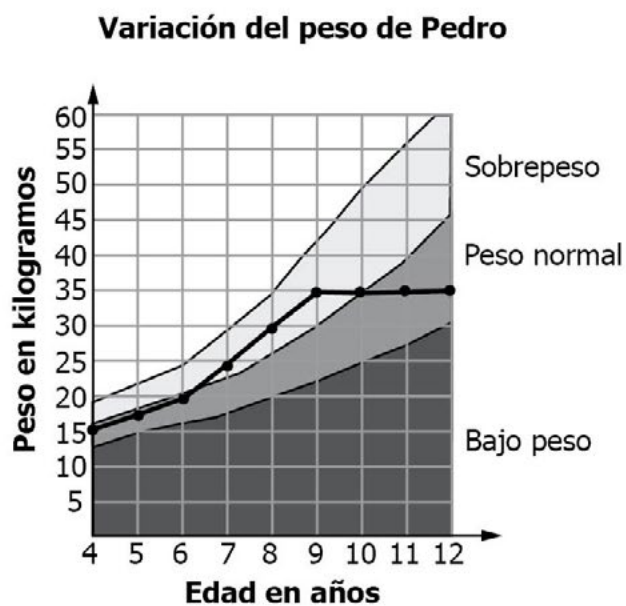
Años	Peso en kilogramos
4	15
6	20
8	30
10	35
12	35

B.

Años	Peso en kilogramos
4	15
6	20
8	25
10	30
12	35

C.

Años	Peso en kilogramos
7	25
8	30
9	35
10	40
11	45

D.

Años	Peso en kilogramos
7	25
8	26
9	27
10	27
11	27

- **Estructura**

Competencia	Comunicación, representación y modelación
Componente	Aleatorio
Afirmación	Reconocer relaciones entre diferentes representaciones de un conjunto de datos y analizar la pertinencia de la representación.
Nivel de desempeño	Mínimo
Respuesta Correcta	A

- **Resultados a nivel nacional y de Entidad Territorial Certificada (ETC)**

ETC/País	A	B	C	D	Omisión y multimarca	Nº estudiantes
Amazonas	53.7%	24.9%	14.9%	5.1%	1.5%	410
Antioquia	65.7%	17.7%	11.1%	4.6%	0.8%	13193
Apartadó	57.5%	21.2%	15.0%	5.5%	0.8%	779
Arauca	73.6%	14.3%	8.6%	2.7%	0.8%	1241
Armenia	73.5%	13.5%	9.5%	3.2%	0.2%	1844
Atlántico	59.7%	20.2%	13.3%	6.0%	0.8%	3381
Barrancabermeja	70.7%	16.1%	9.5%	3.0%	0.7%	1305
Barranquilla	71.7%	14.7%	9.4%	3.3%	0.9%	6498
Bello	70.5%	15.4%	9.6%	4.0%	0.5%	2368
Bogotá, D.C.	80.0%	9.8%	5.6%	2.1%	2.5%	46578
Bolívar	55.5%	22.1%	15.2%	6.0%	1.2%	5376
Boyacá	74.4%	13.7%	8.3%	3.3%	0.4%	5619
Bucaramanga	83.5%	9.2%	4.9%	2.1%	0.2%	3739
Buenaventura	56.5%	22.6%	13.2%	5.9%	1.8%	1742
Buga	68.0%	15.1%	10.9%	3.5%	2.5%	635
Caldas	69.4%	16.8%	9.3%	4.2%	0.3%	3338
Cali	73.4%	13.6%	8.4%	3.1%	1.5%	12349
Caquetá	66.5%	19.0%	10.5%	3.5%	0.5%	1128
Cartagena	67.1%	17.3%	10.8%	3.9%	0.8%	6516
Cartago	76.0%	10.5%	9.9%	2.8%	0.8%	608
Casanare	74.1%	14.6%	8.4%	2.4%	0.5%	1433
Cauca	64.5%	17.7%	12.1%	4.6%	1.1%	5696
Cesar	64.2%	18.6%	11.5%	5.3%	0.5%	3686
Chocó	43.4%	27.1%	20.0%	7.8%	1.6%	1417
Chía	84.1%	9.9%	3.9%	1.8%	0.3%	971

Continúa en la siguiente página

GRADO 9° - MATEMÁTICAS

ETC/País	A	B	C	D	Omisión y multimarca	N° estudiantes
Ciénaga	57.3%	22.8%	12.4%	6.6%	0.9%	747
Cundinamarca	78.1%	11.5%	6.8%	3.0%	0.6%	9588
Córdoba	54.5%	23.5%	15.4%	5.8%	0.9%	6073
Cúcuta	77.2%	12.2%	7.6%	2.8%	0.3%	4355
Dosquebradas	78.3%	11.5%	7.2%	2.4%	0.6%	931
Duitama	88.6%	7.0%	2.8%	0.9%	0.5%	951
Envigado	81.6%	9.2%	6.3%	2.3%	0.6%	1332
Facatativá	76.6%	13.3%	7.1%	2.5%	0.5%	791
Florencia	73.7%	14.3%	8.3%	3.1%	0.6%	932
Floridablanca	83.5%	9.2%	4.6%	1.9%	0.7%	1551
Fusagasugá	79.5%	10.1%	7.8%	1.9%	0.7%	854
Girardot	69.8%	16.0%	10.4%	2.9%	1.0%	731
Girón	77.9%	10.1%	8.7%	2.4%	1.0%	716
Guainía	100.0%	0.0%	0.0%	0.0%	0.0%	2
Guaviare	63.8%	18.0%	13.7%	3.2%	1.2%	495
Huila	73.3%	15.4%	8.6%	2.5%	0.2%	4000
Ibagué	78.2%	11.7%	6.9%	2.8%	0.4%	3313
Ipiales	77.2%	10.5%	8.6%	2.6%	1.1%	725
Itagüí	67.9%	16.1%	11.1%	3.7%	1.2%	1267
Jamundí	66.2%	17.8%	11.5%	4.1%	0.3%	684
La Guajira	58.3%	20.4%	13.0%	6.8%	1.5%	1358
Lorica	52.7%	25.9%	15.5%	5.5%	0.4%	931
Magangué	60.9%	20.1%	12.6%	5.6%	0.8%	751
Magdalena	53.0%	24.5%	15.5%	5.8%	1.2%	3737
Maicao	58.6%	22.2%	12.4%	5.5%	1.3%	850
Malambo	65.7%	14.7%	14.4%	4.6%	0.5%	563
Manizales	74.4%	13.6%	8.4%	3.3%	0.4%	2369
Medellín	71.4%	14.7%	9.4%	3.6%	0.8%	13275
Meta	71.5%	15.3%	8.7%	3.5%	1.0%	2478
Montería	67.1%	16.8%	10.8%	4.1%	1.2%	2840
Mosquera	80.2%	11.2%	6.1%	2.3%	0.3%	771
Nariño	71.5%	14.9%	8.8%	3.1%	1.7%	4306
Neiva	80.2%	11.1%	6.6%	1.9%	0.2%	2436
Norte de Santander	72.7%	15.0%	8.6%	3.1%	0.7%	3660
Palmira	77.8%	12.9%	6.0%	2.6%	0.8%	1677
Pasto	81.6%	10.7%	5.5%	1.9%	0.4%	2706
Pereira	76.8%	13.2%	7.2%	2.2%	0.6%	2789
Piedecuesta	78.6%	11.0%	7.5%	2.3%	0.6%	855
Pitalito	78.2%	12.7%	6.4%	2.4%	0.3%	763

Continúa en la siguiente página



ETC/País	A	B	C	D	Omisión y multimarca	N° estudiantes
Popayán	79.6%	9.9%	7.0%	2.0%	1.4%	1832
Putumayo	73.6%	15.1%	7.9%	2.6%	0.8%	1989
Quibdó	52.2%	21.6%	16.2%	7.2%	2.8%	878
Quindío	70.6%	15.5%	9.9%	3.7%	0.3%	1688
Riohacha	60.5%	20.9%	13.3%	4.5%	0.8%	958
Rionegro	78.3%	10.4%	7.5%	3.4%	0.5%	830
Risaralda	71.4%	15.4%	9.6%	3.2%	0.4%	1501
Sabaneta	76.9%	13.3%	5.8%	4.0%	0.0%	377
Sahagún	58.9%	21.4%	13.8%	5.4%	0.5%	791
San Andrés	61.0%	16.7%	13.0%	6.5%	2.8%	354
Santa Marta	63.9%	18.3%	11.0%	5.9%	0.9%	2899
Santander	78.4%	11.7%	6.7%	2.8%	0.4%	4612
Sincelejo	70.1%	15.8%	10.2%	3.4%	0.5%	2119
Soacha	77.0%	12.1%	7.7%	2.7%	0.5%	3300
Sogamoso	83.9%	8.0%	6.2%	1.9%	0.0%	964
Soledad	69.9%	15.4%	9.9%	3.8%	0.9%	2583
Sucre	56.2%	22.9%	14.4%	5.6%	0.9%	3938
Tolima	66.7%	17.8%	10.8%	4.2%	0.6%	5129
Tuluá	72.6%	15.2%	8.7%	3.0%	0.5%	1315
Tumaco	57.5%	21.1%	14.7%	5.2%	1.6%	872
Tunja	85.3%	8.7%	4.6%	1.0%	0.4%	1175
Turbo	49.3%	21.6%	20.8%	6.8%	1.5%	804
Uribe	58.4%	18.1%	12.8%	10.1%	0.7%	149
Valle del Cauca	68.4%	16.3%	10.5%	3.8%	1.0%	4706
Valledupar	65.7%	17.2%	11.0%	5.1%	0.9%	2690
Vaupés	25.0%	0.0%	25.0%	0.0%	50.0%	4
Vichada	67.7%	16.2%	11.8%	3.1%	1.3%	229
Villavicencio	78.0%	12.1%	7.2%	2.2%	0.4%	3070
Yopal	80.4%	9.3%	7.6%	2.3%	0.4%	988
Yumbo	73.7%	14.9%	8.0%	2.4%	0.9%	737
Zipaquirá	82.2%	9.5%	6.5%	1.6%	0.2%	852
Colombia	71.7%	14.7%	9.1%	3.5%	1.1%	275336

*Es posible que los porcentajes mostrados no sumen exactamente 100 debido a aproximaciones decimales.

• Pregunta 15.

¿Cuál de las siguientes afirmaciones sobre el peso de Pedro es correcta?

- A. Tuvo peso normal de los 4 a los 12 años.
- B. Tuvo peso normal de los 9 a los 12 años.
- C. Tuvo sobrepeso de los 7 a los 9 años.
- D. Tuvo bajo peso de los 4 a los 6 años.

• Estructura

Competencia	Comunicación, representación y modelación
Componente	Numérico - variacional
Afirmación	Identificar características de gráficas cartesianas en relación con la situación que representan.
Nivel de desempeño	Satisfactorio
Respuesta Correcta	C

• Resultados a nivel nacional y de Entidad Territorial Certificada (ETC)

ETC/País	A	B	C	D	Omisión y multimarca	N° estudiantes
Amazonas	26.3%	34.6%	25.1%	11.2%	2.7%	410
Antioquia	21.5%	30.6%	33.7%	13.2%	1.0%	13193
Apartadó	22.8%	32.3%	30.7%	13.4%	0.8%	779
Arauca	18.3%	31.2%	38.4%	11.4%	0.7%	1241
Armenia	14.4%	28.8%	44.6%	11.9%	0.3%	1844
Atlántico	22.8%	31.9%	31.6%	12.4%	1.3%	3381
Barrancabermeja	19.1%	29.6%	38.0%	12.6%	0.7%	1305
Barranquilla	19.7%	30.3%	38.2%	10.7%	1.2%	6498
Bello	19.9%	28.3%	38.4%	12.6%	0.7%	2368
Bogotá, D.C.	14.0%	25.2%	48.1%	10.1%	2.6%	46578
Bolívar	23.7%	33.4%	28.0%	13.6%	1.4%	5376
Boyacá	17.1%	31.2%	40.3%	11.0%	0.4%	5619
Bucaramanga	12.4%	27.0%	49.8%	10.4%	0.4%	3739
Buenaventura	21.6%	34.5%	27.9%	13.7%	2.2%	1742
Buga	18.6%	31.5%	37.5%	9.6%	2.8%	635
Caldas	20.5%	31.8%	34.4%	12.8%	0.5%	3338
Cali	16.9%	28.7%	41.0%	11.6%	1.8%	12349
Caquetá	20.8%	33.3%	32.5%	12.1%	1.2%	1128
Cartagena	21.6%	30.2%	35.3%	11.7%	1.2%	6516
Cartago	17.1%	31.6%	39.8%	10.5%	1.0%	608
Casanare	16.6%	35.1%	36.8%	10.5%	0.9%	1433
Cauca	23.1%	33.4%	28.6%	13.6%	1.3%	5696
Cesar	23.3%	35.1%	29.0%	11.8%	0.8%	3686
Chocó	27.0%	30.0%	23.8%	17.4%	1.8%	1417
Chía	13.5%	21.0%	54.6%	10.8%	0.1%	971
Ciénaga	23.8%	31.2%	31.1%	12.7%	1.2%	747
Cundinamarca	16.0%	31.0%	41.2%	11.2%	0.7%	9588
Córdoba	23.4%	33.6%	27.6%	14.1%	1.2%	6073
Cúcuta	17.4%	31.3%	40.7%	10.2%	0.4%	4355
Dosquebradas	16.1%	29.0%	41.5%	12.8%	0.6%	931
Duitama	11.6%	22.4%	55.7%	9.8%	0.5%	951
Envigado	14.6%	20.9%	53.5%	10.2%	0.8%	1332
Facatativá	14.7%	29.8%	44.8%	10.2%	0.5%	791
Florencia	16.2%	30.9%	38.3%	13.7%	0.9%	932
Floridablanca	11.5%	25.4%	51.3%	11.1%	0.6%	1551
Fusagasugá	13.6%	30.9%	46.1%	9.0%	0.4%	854
Girardot	19.4%	32.7%	35.8%	10.8%	1.2%	731

Continúa en la siguiente página

GRADO 9° - MATEMÁTICAS

ETC/País	A	B	C	D	Omisión y multimarca	N° estudiantes
Girón	14.2%	31.6%	40.6%	12.7%	0.8%	716
Guainía	50.0%	50.0%	0.0%	0.0%	0.0%	2
Guaviare	16.2%	38.0%	29.9%	13.7%	2.2%	495
Huila	18.3%	32.8%	36.0%	12.4%	0.5%	4000
Ibagué	15.2%	30.4%	43.6%	10.1%	0.6%	3313
Ipiales	16.7%	32.8%	39.4%	9.8%	1.2%	725
Itagüí	20.1%	27.5%	40.0%	10.8%	1.6%	1267
Jamundí	20.8%	33.3%	34.5%	11.0%	0.4%	684
La Guajira	22.5%	31.4%	29.6%	14.7%	1.8%	1358
Lorica	24.8%	36.3%	24.6%	13.5%	0.8%	931
Magangué	22.5%	36.1%	28.5%	12.1%	0.8%	751
Magdalena	25.3%	34.1%	25.2%	13.9%	1.5%	3737
Maicao	20.5%	38.2%	27.6%	12.0%	1.6%	850
Malambo	20.8%	31.4%	35.9%	11.0%	0.9%	563
Manizales	16.7%	29.1%	40.7%	12.9%	0.6%	2369
Medellín	18.8%	27.8%	40.6%	11.8%	0.9%	13275
Meta	19.1%	31.8%	37.1%	10.7%	1.3%	2478
Montería	20.1%	31.4%	35.7%	11.2%	1.7%	2840
Mosquera	13.5%	28.0%	46.7%	11.8%	0.0%	771
Nariño	20.1%	32.0%	35.0%	11.0%	2.0%	4306
Neiva	14.9%	29.3%	45.8%	9.6%	0.4%	2436
Norte de Santander	18.4%	31.5%	37.2%	11.9%	0.9%	3660
Palmira	16.8%	30.1%	40.5%	11.9%	0.8%	1677
Pasto	15.5%	30.0%	44.2%	9.8%	0.5%	2706
Pereira	17.3%	27.1%	44.1%	10.6%	0.8%	2789
Piedecuesta	17.0%	28.9%	40.9%	11.5%	1.8%	855
Pitalito	15.9%	32.1%	40.2%	11.5%	0.3%	763
Popayán	14.9%	29.8%	41.3%	12.3%	1.7%	1832
Putumayo	19.5%	32.2%	37.0%	10.5%	0.9%	1989
Quibdó	24.7%	30.8%	24.5%	16.9%	3.2%	878
Quindío	18.7%	31.8%	36.7%	12.5%	0.3%	1688
Riohacha	23.1%	30.9%	31.8%	12.7%	1.5%	958
Rionegro	17.6%	28.6%	41.8%	11.3%	0.7%	830
Risaralda	21.7%	32.6%	33.7%	11.3%	0.7%	1501
Sabaneta	14.1%	27.1%	46.4%	11.9%	0.5%	377
Sahagún	20.7%	34.9%	30.5%	13.5%	0.4%	791
San Andrés	17.8%	32.2%	33.9%	13.8%	2.3%	354
Santa Marta	22.8%	30.1%	33.8%	12.2%	1.1%	2899
Santander	15.4%	30.6%	41.4%	12.0%	0.5%	4612

Continúa en la siguiente página



ETC/País	A	B	C	D	Omisión y multimarca	N° estudiantes
Sincelejo	22.7%	31.2%	33.1%	12.4%	0.6%	2119
Soacha	17.5%	32.3%	38.6%	10.9%	0.6%	3300
Sogamoso	14.5%	27.5%	48.1%	9.6%	0.2%	964
Soledad	20.6%	29.7%	36.2%	12.5%	1.0%	2583
Sucre	22.8%	34.4%	28.6%	13.1%	1.0%	3938
Tolima	21.1%	33.6%	32.0%	12.7%	0.7%	5129
Tuluá	18.2%	34.5%	33.8%	12.7%	0.8%	1315
Tumaco	23.7%	34.7%	23.5%	16.1%	1.9%	872
Tunja	14.3%	25.0%	50.6%	9.6%	0.4%	1175
Turbo	24.5%	30.8%	28.0%	14.9%	1.7%	804
Uribe	24.2%	41.6%	27.5%	6.7%	0.0%	149
Valle del Cauca	19.8%	35.2%	32.6%	11.3%	1.1%	4706
Valledupar	21.7%	31.5%	32.0%	13.6%	1.2%	2690
Vaupés	0.0%	25.0%	25.0%	0.0%	50.0%	4
Vichada	18.8%	41.5%	23.6%	14.4%	1.7%	229
Villavicencio	15.8%	28.8%	43.9%	11.0%	0.5%	3070
Yopal	15.3%	30.5%	43.7%	10.3%	0.2%	988
Yumbo	19.7%	31.8%	33.9%	13.3%	1.4%	737
Zipaquirá	14.6%	28.8%	45.8%	10.6%	0.4%	852
Colombia	18.3%	30.0%	38.8%	11.7%	1.3%	275336

*Es posible que los porcentajes mostrados no sumen exactamente 100 debido a aproximaciones decimales.

• **Pregunta 16.**

Con la información que aparece en la siguiente tabla,

¿Has ido al médico en el último mes?	Número de personas
Sí	40
No	120

Tania elaboró correctamente el diagrama de barras que aparece a continuación.



¿Qué números escribió Tania en la posición indicada por los óvalos *E*, *F* y *G* respectivamente?

- A. 0, 40, 120
- B. 0, 100, 200
- C. 40, 120, 150
- D. 50, 100, 150

• **Estructura**

Competencia	Comunicación, representación y modelación
Componente	Aleatorio
Afirmación	Reconocer relaciones entre diferentes representaciones de un conjunto de datos y analizar la pertinencia de la representación.
Nivel de desempeño	Satisfactorio
Respuesta Correcta	D

• Resultados a nivel nacional y de Entidad Territorial Certificada (ETC)

ETC/País	A	B	C	D	Omisión y multimarca	N° estudiantes
Amazonas	40.0%	7.6%	23.4%	25.1%	3.9%	410
Antioquia	34.8%	7.9%	21.0%	34.8%	1.4%	13193
Apartadó	32.5%	11.2%	26.6%	28.4%	1.4%	779
Arauca	26.4%	7.0%	21.2%	44.4%	1.0%	1241
Armenia	25.7%	8.4%	19.5%	45.8%	0.7%	1844
Atlántico	38.3%	8.7%	19.7%	31.7%	1.7%	3381
Barrancabermeja	29.6%	7.4%	21.0%	40.9%	1.1%	1305
Barranquilla	31.9%	7.2%	18.8%	40.3%	1.7%	6498
Bello	30.5%	7.9%	21.1%	39.2%	1.3%	2368
Bogotá, D.C.	20.7%	5.3%	16.6%	54.4%	3.0%	46578
Bolívar	40.0%	9.4%	22.4%	26.3%	2.0%	5376
Boyacá	27.9%	6.5%	19.3%	45.3%	1.0%	5619
Bucaramanga	20.6%	5.1%	16.6%	57.0%	0.7%	3739
Buenaventura	41.1%	9.3%	20.1%	26.5%	3.0%	1742
Buga	29.0%	8.2%	21.1%	38.4%	3.3%	635
Caldas	33.0%	7.2%	20.5%	38.3%	1.0%	3338
Cali	26.5%	7.0%	19.8%	44.4%	2.3%	12349
Caquetá	36.1%	7.4%	20.9%	34.4%	1.2%	1128
Cartagena	32.6%	8.3%	20.8%	36.4%	1.9%	6516
Cartago	27.6%	7.1%	19.4%	44.2%	1.6%	608
Casanare	30.1%	6.5%	21.4%	40.8%	1.2%	1433
Cauca	39.8%	8.6%	20.8%	28.9%	1.9%	5696
Cesar	37.0%	7.8%	22.4%	31.6%	1.3%	3686
Chocó	45.1%	11.0%	23.4%	18.6%	2.0%	1417
Chía	19.6%	3.6%	16.4%	59.9%	0.5%	971
Ciénaga	40.2%	9.2%	23.8%	25.4%	1.3%	747
Cundinamarca	25.3%	5.8%	18.9%	48.9%	1.1%	9588
Córdoba	39.8%	9.9%	23.0%	25.5%	1.8%	6073
Cúcuta	25.8%	6.9%	18.5%	47.7%	1.0%	4355
Dosquebradas	26.7%	5.5%	18.8%	47.8%	1.2%	931
Duitama	14.7%	4.4%	17.7%	62.7%	0.5%	951
Envigado	19.1%	6.2%	15.2%	58.0%	1.4%	1332
Facatativá	20.2%	6.7%	21.1%	51.3%	0.6%	791
Florencia	32.7%	7.3%	19.3%	39.5%	1.2%	932
Floridablanca	19.1%	4.9%	16.6%	58.1%	1.3%	1551
Fusagasugá	21.1%	6.9%	18.0%	52.8%	1.2%	854
Girardot	28.9%	7.1%	19.7%	43.1%	1.2%	731

Continúa en la siguiente página

GRADO 9° - MATEMÁTICAS

ETC/País	A	B	C	D	Omisión y multimarca	N° estudiantes
Girón	22.1%	6.1%	19.7%	50.7%	1.4%	716
Guainía	50.0%	50.0%	0.0%	0.0%	0.0%	2
Guaviare	36.2%	10.1%	20.2%	30.5%	3.0%	495
Huila	31.3%	6.1%	21.5%	40.3%	0.9%	4000
Ibagué	25.4%	6.5%	19.8%	47.5%	0.9%	3313
Ipiales	22.6%	5.4%	20.4%	49.7%	1.9%	725
Itagüí	27.4%	8.1%	21.2%	41.4%	2.1%	1267
Jamundí	34.6%	8.3%	21.8%	34.1%	1.2%	684
La Guajira	39.2%	8.9%	20.0%	29.8%	2.1%	1358
Lorica	43.3%	10.7%	20.6%	23.6%	1.7%	931
Magangué	35.8%	8.0%	22.2%	32.9%	1.1%	751
Magdalena	45.4%	10.2%	21.0%	21.5%	1.8%	3737
Maicao	40.8%	8.0%	22.9%	25.5%	2.7%	850
Malambo	37.7%	9.2%	18.7%	33.0%	1.4%	563
Manizales	28.5%	6.4%	19.3%	44.9%	0.9%	2369
Medellín	26.6%	7.9%	20.5%	43.6%	1.4%	13275
Meta	30.3%	7.2%	19.5%	41.2%	1.9%	2478
Montería	31.5%	8.3%	24.4%	33.8%	2.0%	2840
Mosquera	24.3%	5.2%	15.3%	55.1%	0.1%	771
Nariño	32.2%	5.8%	20.7%	39.1%	2.2%	4306
Neiva	23.3%	6.2%	18.3%	51.4%	0.8%	2436
Norte de Santander	29.7%	6.9%	20.8%	41.3%	1.4%	3660
Palmira	25.3%	6.5%	18.2%	48.7%	1.3%	1677
Pasto	21.5%	5.4%	17.7%	54.4%	1.0%	2706
Pereira	25.5%	6.9%	19.2%	47.3%	1.1%	2789
Piedecuesta	22.2%	8.2%	17.4%	50.3%	1.9%	855
Pitalito	28.7%	6.2%	18.2%	46.3%	0.7%	763
Popayán	24.6%	6.2%	18.8%	48.0%	2.3%	1832
Putumayo	28.0%	7.5%	21.5%	41.9%	1.1%	1989
Quibdó	40.8%	9.6%	20.0%	26.1%	3.5%	878
Quindío	29.2%	7.0%	23.4%	39.5%	0.9%	1688
Riohacha	37.2%	9.3%	19.3%	32.5%	1.8%	958
Rionegro	25.8%	7.1%	18.3%	48.2%	0.6%	830
Risaralda	35.8%	7.3%	19.2%	36.6%	1.1%	1501
Sabaneta	19.1%	5.6%	16.7%	58.4%	0.3%	377
Sahagún	34.4%	11.4%	23.0%	30.2%	1.0%	791
San Andrés	32.8%	10.7%	19.8%	33.3%	3.4%	354
Santa Marta	35.7%	8.0%	19.9%	34.7%	1.8%	2899
Santander	27.6%	5.8%	18.7%	47.0%	0.8%	4612

Continúa en la siguiente página



ETC/País	A	B	C	D	Omisión y multimarca	N° estudiantes
Sincelejo	33.6%	7.6%	19.8%	38.2%	0.9%	2119
Soacha	25.1%	5.7%	21.3%	46.8%	1.1%	3300
Sogamoso	17.3%	6.2%	18.2%	58.1%	0.2%	964
Soledad	32.1%	7.9%	21.0%	37.6%	1.4%	2583
Sucre	39.6%	9.6%	23.5%	25.7%	1.5%	3938
Tolima	36.7%	7.9%	20.6%	33.2%	1.5%	5129
Tuluá	31.9%	6.0%	21.4%	39.5%	1.2%	1315
Tumaco	40.8%	9.2%	22.0%	25.3%	2.6%	872
Tunja	19.7%	4.0%	17.4%	58.0%	0.9%	1175
Turbo	44.4%	10.7%	23.1%	19.7%	2.1%	804
Uribe	45.0%	7.4%	22.1%	25.5%	0.0%	149
Valle del Cauca	34.4%	7.8%	21.4%	34.5%	1.9%	4706
Valledupar	35.5%	7.8%	19.4%	35.6%	1.8%	2690
Vaupés	50.0%	0.0%	0.0%	0.0%	50.0%	4
Vichada	41.5%	6.1%	24.5%	25.3%	2.6%	229
Villavicencio	26.0%	6.0%	18.4%	48.7%	1.0%	3070
Yopal	23.0%	4.9%	18.2%	53.3%	0.6%	988
Yumbo	31.9%	7.9%	21.8%	36.5%	1.9%	737
Zipacquirá	22.2%	4.8%	17.3%	55.4%	0.4%	852
Colombia	29.2%	7.1%	19.6%	42.4%	1.7%	275336

*Es posible que los porcentajes mostrados no sumen exactamente 100 debido a aproximaciones decimales.

• Pregunta 17.

Para preparar cierto tipo de torta que alcanza para 10 porciones de tamaño mediano, se utilizaron 500 gramos de harina. Para preparar una torta que alcance para 20 porciones del mismo tamaño, ¿cuántas libras de harina se necesitan?

- A. Menos de 1 libra.
- B. Exactamente 1 libra.
- C. Exactamente 2 libras.
- D. Más de 2 libras.

• Estructura

Competencia	Planteamiento y resolución de problemas
Componente	Geométrico - métrico
Afirmación	Resolver problemas de medición utilizando de manera pertinente instrumentos y unidades de medida.
Nivel de desempeño	Avanzado
Respuesta Correcta	C

• Resultados a nivel nacional y de Entidad Territorial Certificada (ETC)

ETC/País	A	B	C	D	Omisión y multimarca	Nº estudiantes
Amazonas	9.5%	36.1%	33.2%	19.3%	2.0%	410
Antioquia	7.3%	41.9%	38.0%	12.1%	0.8%	13193
Apartadó	10.7%	34.8%	36.2%	17.7%	0.6%	779
Arauca	8.3%	35.5%	46.7%	8.8%	0.6%	1241
Armenia	8.5%	45.9%	36.0%	9.4%	0.2%	1844
Atlántico	9.4%	35.0%	35.2%	19.6%	0.7%	3381
Barrancabermeja	9.0%	41.1%	36.9%	12.3%	0.6%	1305
Barranquilla	7.9%	40.5%	38.3%	12.4%	0.9%	6498
Bello	7.4%	46.6%	35.9%	9.4%	0.7%	2368
Bogotá, D.C.	5.7%	47.3%	37.3%	7.2%	2.5%	46578
Bolívar	10.1%	31.0%	36.9%	20.7%	1.2%	5376
Boyacá	5.8%	37.4%	45.5%	10.8%	0.4%	5619
Bucaramanga	5.3%	47.0%	40.2%	7.2%	0.3%	3739
Buenaventura	10.2%	32.5%	36.7%	18.4%	2.2%	1742
Buga	6.5%	42.0%	39.8%	8.8%	2.8%	635
Caldas	7.6%	39.7%	43.0%	9.3%	0.3%	3338
Cali	7.1%	41.4%	39.7%	10.3%	1.6%	12349
Caquetá	7.9%	27.6%	53.1%	11.0%	0.4%	1128
Cartagena	9.5%	39.3%	34.1%	16.2%	1.0%	6516
Cartago	7.6%	46.5%	37.7%	7.2%	1.0%	608
Casanare	8.5%	35.7%	44.9%	10.3%	0.6%	1433
Cauca	6.3%	28.3%	48.4%	15.9%	1.0%	5696
Cesar	7.7%	31.3%	45.3%	15.5%	0.4%	3686
Chocó	11.6%	26.5%	33.9%	26.6%	1.3%	1417
Chía	5.3%	53.8%	34.6%	6.1%	0.3%	971
Ciénaga	9.4%	35.9%	36.4%	17.3%	1.1%	747
Cundinamarca	5.6%	41.0%	43.9%	9.0%	0.6%	9588
Córdoba	9.8%	32.5%	34.5%	22.3%	1.0%	6073
Cúcuta	7.1%	44.8%	38.3%	9.4%	0.4%	4355
Dosquebradas	5.3%	50.3%	34.4%	9.3%	0.8%	931
Duitama	5.4%	46.8%	41.1%	6.4%	0.3%	951
Envigado	5.8%	55.8%	30.3%	7.1%	1.0%	1332
Facatativá	5.8%	49.1%	38.7%	6.2%	0.3%	791
Florencia	6.0%	40.2%	44.4%	8.8%	0.5%	932
Floridablanca	4.1%	48.7%	40.0%	6.7%	0.6%	1551
Fusagasugá	6.7%	43.6%	41.1%	7.7%	0.9%	854
Girardot	8.3%	41.6%	40.6%	8.3%	1.1%	731

Continúa en la siguiente página

GRADO 9° - MATEMÁTICAS

ETC/País	A	B	C	D	Omisión y multimarca	N° estudiantes
Girón	8.2%	43.3%	38.4%	9.2%	0.8%	716
Guainía	0.0%	50.0%	0.0%	50.0%	0.0%	2
Guaviare	6.3%	33.5%	47.7%	11.3%	1.2%	495
Huila	6.3%	33.0%	48.8%	11.6%	0.3%	4000
Ibagué	6.5%	43.7%	40.4%	8.8%	0.6%	3313
Ipiales	4.0%	46.3%	38.2%	9.8%	1.7%	725
Itagüí	9.9%	43.7%	34.0%	11.3%	1.1%	1267
Jamundí	7.0%	35.4%	42.4%	14.8%	0.4%	684
La Guajira	10.1%	35.3%	34.6%	18.5%	1.5%	1358
Lorica	10.0%	33.0%	32.0%	24.4%	0.6%	931
Magangué	7.9%	36.1%	34.0%	21.4%	0.7%	751
Magdalena	9.5%	28.8%	37.5%	23.3%	0.9%	3737
Maicao	10.2%	39.9%	28.1%	20.2%	1.5%	850
Malambo	11.4%	27.2%	43.0%	17.9%	0.5%	563
Manizales	7.5%	46.9%	37.1%	7.9%	0.6%	2369
Medellín	8.4%	49.4%	32.0%	9.3%	0.9%	13275
Meta	7.0%	37.2%	44.0%	10.6%	1.1%	2478
Montería	7.7%	38.3%	36.4%	16.2%	1.4%	2840
Mosquera	6.9%	47.0%	36.7%	9.2%	0.3%	771
Nariño	5.6%	36.3%	42.8%	13.6%	1.7%	4306
Neiva	6.6%	41.0%	42.7%	9.6%	0.2%	2436
Norte de Santander	6.6%	40.5%	41.6%	10.6%	0.7%	3660
Palmira	6.4%	41.0%	44.1%	7.8%	0.7%	1677
Pasto	5.1%	46.9%	38.5%	9.2%	0.4%	2706
Pereira	6.4%	48.4%	35.6%	9.0%	0.5%	2789
Piedecuesta	7.8%	43.6%	37.1%	10.8%	0.7%	855
Pitalito	5.6%	38.8%	44.6%	11.0%	0.0%	763
Popayán	6.1%	43.2%	40.5%	8.6%	1.6%	1832
Putumayo	5.8%	32.4%	49.3%	11.7%	0.8%	1989
Quibdó	12.0%	31.7%	32.6%	20.6%	3.2%	878
Quindío	6.9%	42.2%	40.1%	10.5%	0.2%	1688
Riohacha	10.4%	39.1%	31.6%	17.8%	0.9%	958
Rionegro	6.5%	50.6%	34.5%	8.0%	0.5%	830
Risaralda	6.4%	42.2%	41.0%	9.9%	0.5%	1501
Sabaneta	6.9%	53.3%	32.6%	7.2%	0.0%	377
Sahagún	7.8%	38.2%	36.4%	17.3%	0.3%	791
San Andrés	9.0%	35.3%	34.7%	18.4%	2.5%	354
Santa Marta	8.7%	40.6%	36.6%	13.2%	0.9%	2899
Santander	5.9%	36.8%	48.5%	8.3%	0.6%	4612

Continúa en la siguiente página



ETC/País	A	B	C	D	Omisión y multimarca	N° estudiantes
Sincelejo	8.8%	39.5%	36.4%	14.7%	0.5%	2119
Soacha	7.4%	41.7%	41.3%	9.2%	0.5%	3300
Sogamoso	5.5%	50.1%	37.4%	6.8%	0.1%	964
Soledad	7.8%	36.6%	40.4%	14.1%	1.0%	2583
Sucre	9.7%	31.7%	36.8%	21.3%	0.5%	3938
Tolima	6.5%	32.9%	48.1%	11.9%	0.6%	5129
Tuluá	7.5%	44.9%	37.3%	9.7%	0.6%	1315
Tumaco	8.0%	29.5%	41.5%	19.3%	1.7%	872
Tunja	4.3%	51.4%	35.2%	8.5%	0.6%	1175
Turbo	11.2%	29.2%	37.8%	20.5%	1.2%	804
Uribe	10.7%	34.2%	37.6%	17.4%	0.0%	149
Valle del Cauca	7.5%	36.1%	43.3%	12.1%	1.0%	4706
Valledupar	7.7%	38.8%	37.8%	14.8%	0.9%	2690
Vaupés	0.0%	0.0%	25.0%	25.0%	50.0%	4
Vichada	6.6%	35.4%	46.7%	9.2%	2.2%	229
Villavicencio	6.6%	43.3%	41.5%	8.1%	0.5%	3070
Yopal	5.1%	44.3%	41.7%	8.8%	0.1%	988
Yumbo	6.9%	41.5%	40.8%	9.8%	0.9%	737
Zipaquirá	4.5%	49.2%	38.3%	7.7%	0.4%	852
Colombia	7.1%	41.0%	39.2%	11.5%	1.1%	275336

*Es posible que los porcentajes mostrados no sumen exactamente 100 debido a aproximaciones decimales.

• **Pregunta 18.**

En un campeonato de fútbol de un colegio participan 4 equipos (E, F, G, H) de los cuales clasifican a la final los dos que obtengan mayor cantidad de puntos después de enfrentarse todos contra todos, una sola vez. En cada partido el equipo ganador obtiene 3 puntos y el perdedor 0 puntos; en caso de empate cada equipo obtiene 1 punto.

Los siguientes son los resultados de los 4 primeros partidos.

Partido 1		Partido 2		Partido 3		Partido 4	
Equipo	Goles	Equipo	Goles	Equipo	Goles	Equipo	Goles
E	3	E	2	F	1	F	3
G	0	H	1	G	0	H	2

Faltan por jugar los partidos entre los equipos E y F y entre los equipos G y H .
¿Cuál o cuáles de las siguientes afirmaciones es o son verdadera(s)?

- I. E ya está clasificado a la final.
 - II. H ya está eliminado de la final.
 - III. G tiene posibilidades de clasificar a la final.
- A. I solamente.
 - B. I y II solamente.
 - C. I y III solamente.
 - D. I, II y III.

• **Estructura**

Competencia	Razonamiento y argumentación
Componente	Numérico - variacional
Afirmación	Utilizar propiedades y relaciones de los números reales para resolver problemas.
Nivel de desempeño	Avanzado
Respuesta Correcta	B



• Resultados a nivel nacional y de Entidad Territorial Certificada (ETC)

ETC/País	A	B	C	D	Omisión y multimarca	N° estudiantes
Amazonas	40.0%	29.3%	16.6%	10.7%	3.4%	410
Antioquia	40.8%	34.3%	14.7%	9.2%	1.1%	13193
Apartadó	39.4%	33.1%	16.9%	9.9%	0.6%	779
Arauca	45.4%	30.8%	14.5%	8.4%	1.0%	1241
Armenia	42.7%	37.5%	12.1%	7.4%	0.3%	1844
Atlántico	41.1%	32.6%	15.4%	9.7%	1.2%	3381
Barrancabermeja	41.1%	35.8%	12.4%	10.1%	0.6%	1305
Barranquilla	41.6%	36.8%	13.4%	7.0%	1.2%	6498
Bello	41.0%	37.8%	11.7%	8.7%	0.7%	2368
Bogotá, D.C.	39.4%	40.7%	10.9%	6.2%	2.8%	46578
Bolívar	40.6%	29.2%	17.2%	11.3%	1.7%	5376
Boyacá	42.7%	34.8%	13.8%	8.0%	0.7%	5619
Bucaramanga	42.0%	40.0%	11.1%	6.4%	0.4%	3739
Buenaventura	39.9%	32.0%	15.2%	10.5%	2.4%	1742
Buga	40.2%	32.3%	17.5%	6.9%	3.1%	635
Caldas	43.9%	33.0%	14.1%	8.2%	0.7%	3338
Cali	40.6%	37.1%	12.9%	7.5%	1.9%	12349
Caquetá	43.1%	32.0%	14.9%	9.0%	1.0%	1128
Cartagena	41.2%	34.8%	14.7%	8.0%	1.4%	6516
Cartago	41.1%	39.8%	11.7%	6.4%	1.0%	608
Casanare	46.0%	32.7%	12.6%	7.9%	0.8%	1433
Cauca	41.0%	31.2%	17.2%	9.1%	1.6%	5696
Cesar	45.1%	29.7%	15.7%	8.6%	0.9%	3686
Chocó	37.6%	29.0%	18.9%	13.1%	1.3%	1417
Chía	38.1%	43.3%	11.0%	7.1%	0.5%	971
Ciénaga	37.8%	35.3%	16.1%	9.9%	0.9%	747
Cundinamarca	43.4%	35.9%	12.4%	7.7%	0.7%	9588
Córdoba	38.3%	31.8%	17.7%	10.6%	1.6%	6073
Cúcuta	43.2%	37.7%	11.8%	6.8%	0.4%	4355
Dosquebradas	44.9%	35.4%	11.8%	6.6%	1.3%	931
Duitama	42.5%	40.8%	9.9%	6.1%	0.7%	951
Envigado	36.9%	44.9%	11.3%	5.7%	1.2%	1332
Facatativá	40.5%	38.9%	11.4%	9.1%	0.1%	791
Florencia	48.2%	31.4%	11.3%	8.4%	0.8%	932
Floridablanca	45.4%	38.2%	9.9%	5.7%	0.8%	1551
Fusagasugá	42.2%	36.4%	13.0%	7.3%	1.2%	854
Girardot	41.6%	35.7%	13.1%	8.2%	1.4%	731

Continúa en la siguiente página

ETC/País	A	B	C	D	Omisión y multimarca	N° estudiantes
Girón	42.7%	36.5%	13.0%	7.0%	0.8%	716
Guainía	50.0%	50.0%	0.0%	0.0%	0.0%	2
Guaviare	46.3%	30.1%	13.5%	9.1%	1.0%	495
Huila	44.8%	31.9%	15.1%	7.6%	0.7%	4000
Ibagué	42.5%	36.8%	12.3%	7.4%	1.0%	3313
Ipiales	41.2%	36.4%	15.3%	5.1%	1.9%	725
Itagüí	36.9%	39.2%	12.9%	9.9%	1.1%	1267
Jamundí	44.3%	31.4%	13.9%	9.9%	0.4%	684
La Guajira	39.9%	30.8%	17.2%	10.5%	1.7%	1358
Lorica	37.8%	33.1%	17.5%	10.8%	0.8%	931
Magangué	41.8%	29.7%	17.6%	9.7%	1.2%	751
Magdalena	39.9%	29.9%	18.4%	10.3%	1.4%	3737
Maicao	34.6%	37.3%	17.4%	8.8%	1.9%	850
Malambo	39.4%	38.5%	13.7%	7.6%	0.7%	563
Manizales	39.0%	39.3%	12.8%	8.2%	0.7%	2369
Medellín	38.5%	38.6%	13.3%	8.5%	1.2%	13275
Meta	42.7%	32.2%	14.6%	8.9%	1.6%	2478
Montería	42.8%	33.8%	14.7%	7.0%	1.7%	2840
Mosquera	43.5%	39.7%	10.0%	6.6%	0.3%	771
Nariño	43.5%	33.9%	13.2%	7.4%	1.9%	4306
Neiva	43.4%	36.7%	12.6%	6.9%	0.5%	2436
Norte de Santander	44.2%	34.3%	13.5%	7.1%	1.0%	3660
Palmira	39.4%	40.0%	12.5%	7.2%	0.9%	1677
Pasto	42.4%	39.4%	11.5%	6.1%	0.7%	2706
Pereira	41.0%	38.0%	13.0%	7.0%	1.0%	2789
Piedecuesta	39.9%	38.0%	13.6%	7.7%	0.8%	855
Pitalito	46.5%	33.3%	12.1%	7.6%	0.5%	763
Popayán	40.3%	38.2%	12.2%	7.5%	1.8%	1832
Putumayo	43.4%	32.4%	14.7%	8.7%	0.8%	1989
Quibdó	39.6%	30.4%	17.8%	8.9%	3.3%	878
Quindío	40.8%	35.7%	12.4%	10.6%	0.6%	1688
Riohacha	44.9%	32.9%	13.9%	6.9%	1.5%	958
Rionegro	37.6%	39.5%	12.7%	9.5%	0.7%	830
Risaralda	48.0%	30.7%	11.5%	9.1%	0.7%	1501
Sabaneta	35.3%	44.0%	12.5%	8.0%	0.3%	377
Sahagún	38.7%	33.1%	17.3%	9.9%	1.0%	791
San Andrés	37.9%	34.5%	14.4%	10.7%	2.5%	354
Santa Marta	39.7%	34.5%	16.4%	8.3%	1.2%	2899
Santander	44.7%	34.9%	13.2%	6.5%	0.8%	4612

Continúa en la siguiente página



ETC/País	A	B	C	D	Omisión y multimarca	N° estudiantes
Sincelejo	41.3%	33.7%	14.8%	9.2%	0.9%	2119
Soacha	41.5%	37.9%	13.1%	6.7%	0.8%	3300
Sogamoso	43.4%	40.7%	10.2%	5.6%	0.2%	964
Soledad	40.3%	36.0%	14.1%	8.1%	1.4%	2583
Sucre	40.7%	31.7%	16.6%	10.2%	0.8%	3938
Tolima	41.9%	31.5%	16.6%	9.3%	0.7%	5129
Tuluá	43.3%	34.8%	14.1%	7.4%	0.4%	1315
Tumaco	41.7%	30.5%	15.0%	10.4%	2.3%	872
Tunja	43.9%	40.2%	8.7%	6.6%	0.6%	1175
Turbo	41.0%	27.2%	19.0%	10.8%	1.9%	804
Uribe	40.9%	33.6%	18.1%	7.4%	0.0%	149
Valle del Cauca	41.6%	33.8%	15.4%	8.0%	1.3%	4706
Valledupar	42.8%	34.1%	13.6%	8.3%	1.2%	2690
Vaupés	25.0%	0.0%	0.0%	25.0%	50.0%	4
Vichada	48.9%	25.8%	16.6%	6.6%	2.2%	229
Villavicencio	43.6%	36.2%	12.5%	7.1%	0.7%	3070
Yopal	44.7%	35.8%	11.4%	7.5%	0.5%	988
Yumbo	42.1%	36.2%	12.5%	8.1%	1.1%	737
Zipacquirá	43.1%	40.8%	10.2%	5.6%	0.2%	852
Colombia	41.2%	36.0%	13.5%	7.9%	1.4%	275336

*Es posible que los porcentajes mostrados no sumen exactamente 100 debido a aproximaciones decimales.

• **Pregunta 19.**

La siguiente figura muestra un polígono irregular situado en un cuadrante del plano cartesiano.

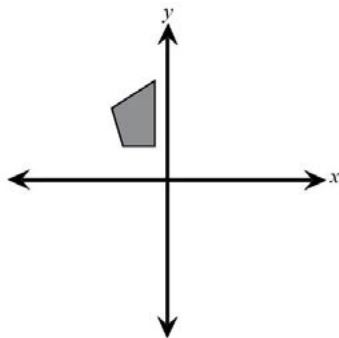

Al polígono se le aplican dos movimientos sucesivos. El primero es una reflexión respecto al eje x ; el segundo es otra reflexión respecto al eje y .

¿Cuál de las siguientes figuras representa la posición del polígono luego de haber efectuado los dos movimientos?

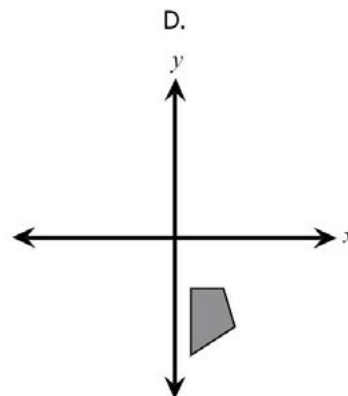
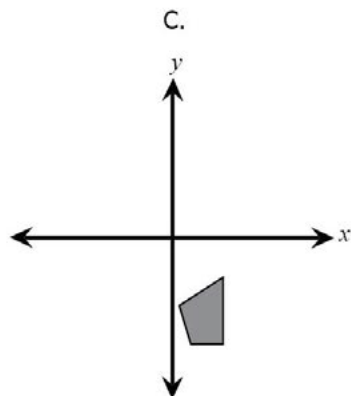
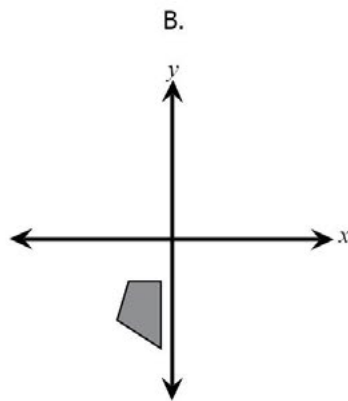
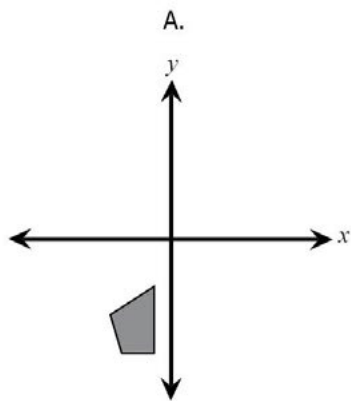

- **Estructura**

Competencia	Razonamiento y argumentación
Componente	Geométrico - métrico
Afirmación	Predecir y explicar los efectos de aplicar transformaciones rígidas sobre figuras bidimensionales.
Nivel de desempeño	Avanzado
Respuesta Correcta	D

- **Resultados a nivel nacional y de Entidad Territorial Certificada (ETC)**

ETC/País	A	B	C	D	Omisión y multimarca	Nº estudiantes
Amazonas	22.9%	19.0%	29.0%	24.1%	4.9%	410
Antioquia	19.9%	20.0%	26.1%	32.1%	1.9%	13193
Apartadó	20.9%	21.4%	26.1%	30.0%	1.5%	779
Arauca	17.9%	19.1%	27.2%	33.8%	2.0%	1241
Armenia	18.8%	20.2%	26.4%	33.9%	0.8%	1844
Atlántico	23.1%	18.6%	26.1%	29.9%	2.3%	3381
Barrancabermeja	20.7%	21.1%	23.8%	32.6%	1.7%	1305
Barranquilla	21.7%	18.7%	24.3%	32.9%	2.4%	6498
Bello	16.7%	19.0%	27.3%	35.0%	1.9%	2368
Bogotá, D.C.	14.4%	16.2%	24.5%	41.3%	3.5%	46578
Bolívar	25.7%	20.6%	25.1%	26.1%	2.5%	5376
Boyacá	17.9%	19.9%	25.1%	35.8%	1.3%	5619
Bucaramanga	15.2%	17.2%	25.2%	41.4%	0.9%	3739
Buenaventura	24.3%	20.0%	25.8%	26.4%	3.4%	1742
Buga	18.1%	17.8%	26.8%	33.2%	4.1%	635
Caldas	19.9%	20.1%	26.9%	31.9%	1.2%	3338
Cali	17.8%	19.2%	25.2%	34.9%	3.0%	12349
Caquetá	23.2%	20.4%	25.4%	29.7%	1.3%	1128
Cartagena	22.2%	19.8%	24.5%	31.2%	2.4%	6516
Cartago	17.8%	19.9%	28.3%	32.6%	1.5%	608
Casanare	16.9%	19.7%	26.5%	34.6%	2.2%	1433
Cauca	21.2%	19.6%	27.0%	29.7%	2.5%	5696
Cesar	22.5%	21.7%	25.2%	29.4%	1.3%	3686
Chocó	27.2%	20.3%	24.6%	25.4%	2.5%	1417
Chía	13.3%	16.5%	22.2%	47.1%	0.9%	971
Ciénaga	25.8%	20.6%	27.2%	24.9%	1.5%	747

Continúa en la siguiente página

ETC/País	A	B	C	D	Omisión y multimarca	N° estudiantes
Cundinamarca	16.9%	18.8%	24.1%	38.6%	1.6%	9588
Córdoba	22.6%	21.4%	26.0%	27.5%	2.5%	6073
Cúcuta	17.5%	18.6%	25.4%	37.2%	1.3%	4355
Dosquebradas	14.9%	18.0%	30.4%	34.5%	2.1%	931
Duitama	15.1%	16.0%	22.1%	45.3%	1.5%	951
Envigado	13.8%	15.3%	20.6%	48.3%	1.9%	1332
Facatativá	15.0%	20.0%	25.4%	38.4%	1.1%	791
Florencia	20.5%	20.7%	28.0%	29.1%	1.7%	932
Floridablanca	15.9%	17.0%	23.2%	42.3%	1.5%	1551
Fusagasugá	18.0%	19.9%	23.2%	36.7%	2.2%	854
Girardot	22.8%	17.1%	26.4%	31.5%	2.2%	731
Girón	20.7%	19.4%	21.1%	37.6%	1.3%	716
Guainía	50.0%	0.0%	0.0%	50.0%	0.0%	2
Guaviare	20.4%	18.6%	28.3%	30.7%	2.0%	495
Huila	19.8%	20.4%	25.7%	32.2%	1.9%	4000
Ibagué	17.8%	18.5%	26.1%	35.9%	1.8%	3313
Ipiales	12.3%	17.4%	29.0%	39.0%	2.3%	725
Itagüí	18.0%	20.6%	24.6%	34.5%	2.3%	1267
Jamundí	24.1%	21.9%	27.5%	24.9%	1.6%	684
La Guajira	23.7%	21.4%	24.1%	28.1%	2.7%	1358
Lorica	27.2%	17.3%	26.7%	27.2%	1.6%	931
Magangué	23.6%	21.2%	24.5%	27.7%	3.1%	751
Magdalena	26.7%	18.7%	24.7%	27.3%	2.7%	3737
Maicao	24.0%	16.8%	28.9%	27.5%	2.7%	850
Malambo	25.4%	16.9%	23.6%	32.9%	1.2%	563
Manizales	16.3%	18.5%	27.6%	36.5%	1.1%	2369
Medellín	17.4%	18.6%	26.4%	35.8%	1.8%	13275
Meta	18.0%	21.2%	26.5%	31.5%	2.8%	2478
Montería	21.1%	19.2%	26.3%	31.0%	2.4%	2840
Mosquera	15.7%	17.6%	25.8%	39.2%	1.7%	771
Nariño	17.3%	19.3%	27.0%	33.6%	2.8%	4306
Neiva	18.1%	21.3%	24.3%	35.0%	1.3%	2436
Norte de Santander	18.6%	18.9%	25.1%	35.6%	1.8%	3660
Palmira	15.6%	18.1%	25.3%	39.2%	1.8%	1677
Pasto	16.0%	17.5%	26.3%	39.2%	1.1%	2706
Pereira	17.3%	18.8%	26.5%	35.9%	1.6%	2789
Piedecuesta	15.1%	17.1%	25.3%	40.4%	2.2%	855
Pitalito	16.3%	25.4%	27.7%	29.4%	1.3%	763
Popayán	17.4%	19.9%	25.6%	34.6%	2.5%	1832

Continúa en la siguiente página



ETC/País	A	B	C	D	Omisión y multimarca	N° estudiantes
Putumayo	19.2%	20.6%	27.0%	31.7%	1.5%	1989
Quibdó	25.3%	19.6%	24.4%	26.8%	4.0%	878
Quindío	18.8%	20.1%	28.1%	31.8%	1.2%	1688
Riohacha	22.2%	21.8%	23.7%	29.6%	2.6%	958
Rionegro	16.5%	18.9%	25.1%	38.3%	1.2%	830
Risaralda	19.3%	19.2%	27.4%	32.9%	1.2%	1501
Sabaneta	14.9%	15.1%	29.2%	40.6%	0.3%	377
Sahagún	21.7%	20.0%	26.5%	30.1%	1.6%	791
San Andrés	21.2%	16.4%	28.2%	30.2%	4.0%	354
Santa Marta	22.2%	18.2%	25.1%	31.9%	2.6%	2899
Santander	17.7%	18.6%	25.0%	37.2%	1.5%	4612
Sincelejo	22.3%	19.3%	25.6%	31.2%	1.7%	2119
Soacha	18.0%	18.5%	26.1%	36.1%	1.3%	3300
Sogamoso	12.3%	18.3%	24.0%	44.1%	1.3%	964
Soledad	20.9%	18.2%	24.2%	34.3%	2.4%	2583
Sucre	26.3%	19.7%	24.9%	27.1%	2.0%	3938
Tolima	21.2%	20.7%	26.0%	30.1%	1.9%	5129
Tuluá	20.2%	20.7%	25.4%	32.0%	1.7%	1315
Tumaco	27.3%	21.2%	24.0%	24.8%	2.8%	872
Tunja	13.4%	16.5%	25.5%	43.5%	1.1%	1175
Turbo	26.0%	20.5%	24.0%	27.0%	2.5%	804
Uribe	20.8%	29.5%	21.5%	26.8%	1.3%	149
Valle del Cauca	19.7%	20.0%	25.6%	32.4%	2.3%	4706
Valledupar	23.6%	19.9%	24.9%	28.8%	2.8%	2690
Vaupés	0.0%	50.0%	0.0%	0.0%	50.0%	4
Vichada	21.8%	19.7%	29.7%	25.8%	3.1%	229
Villavicencio	16.8%	20.9%	25.2%	35.5%	1.6%	3070
Yopal	17.4%	16.5%	24.1%	40.6%	1.4%	988
Yumbo	19.4%	18.9%	28.5%	30.9%	2.3%	737
Zipaquirá	14.2%	15.1%	22.8%	46.8%	1.1%	852
Colombia	18.7%	18.8%	25.4%	34.8%	2.2%	275336

*Es posible que los porcentajes mostrados no sumen exactamente 100 debido a aproximaciones decimales.

• **Pregunta 20.**

En la ilustración se presentan tres balanzas E , F y G . E y F están en equilibrio, pero G no lo está.

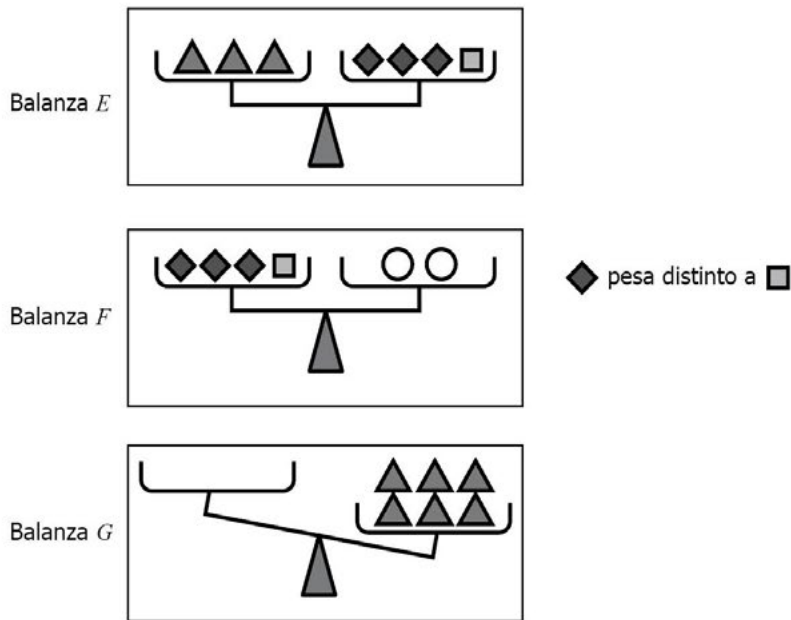

¿Cuáles de los siguientes grupos de pesas se pueden ubicar en el plato desocupado de la balanza G para que quede en equilibrio?

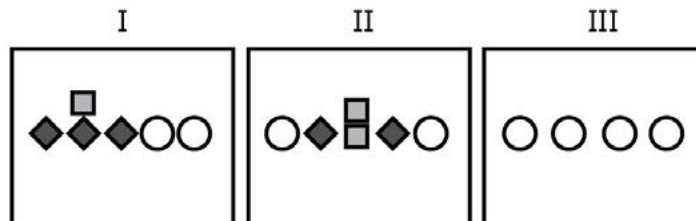

- A. I y II solamente.
- B. I y III solamente.
- C. II y III solamente.
- D. I, II y III.

- **Estructura**

Competencia	Planteamiento y resolución de problemas
Componente	Geométrico - métrico
Afirmación	Resolver problemas de medición utilizando de manera pertinente instrumentos y unidades de medida.
Nivel de desempeño	Avanzado
Respuesta Correcta	B

- **Resultados a nivel nacional y de Entidad Territorial Certificada (ETC)**

ETC/País	A	B	C	D	Omisión y multimarca	Nº estudiantes
Amazonas	36.3%	32.4%	18.0%	9.8%	3.4%	410
Antioquia	38.6%	34.1%	16.7%	9.6%	1.0%	13193
Apartadó	37.7%	35.3%	18.1%	7.8%	1.0%	779
Arauca	36.7%	38.6%	16.4%	7.5%	0.8%	1241
Armenia	36.1%	37.4%	16.7%	9.7%	0.2%	1844
Atlántico	40.0%	33.3%	17.0%	8.4%	1.2%	3381
Barrancabermeja	36.8%	38.6%	15.6%	8.4%	0.7%	1305
Barranquilla	38.2%	36.8%	16.6%	7.4%	1.0%	6498
Bello	35.6%	37.2%	17.3%	9.1%	0.8%	2368
Bogotá, D.C.	31.9%	43.4%	14.9%	6.9%	2.8%	46578
Bolívar	42.1%	31.0%	16.0%	9.4%	1.5%	5376
Boyacá	40.0%	36.4%	15.6%	7.5%	0.6%	5619
Bucaramanga	31.0%	46.9%	14.8%	6.8%	0.4%	3739
Buenaventura	38.9%	31.7%	17.0%	9.7%	2.6%	1742
Buga	33.1%	37.6%	17.0%	9.3%	3.0%	635
Caldas	38.9%	34.1%	16.7%	9.8%	0.4%	3338
Cali	35.9%	38.1%	16.7%	7.4%	1.9%	12349
Caquetá	39.0%	35.4%	17.3%	7.6%	0.7%	1128
Cartagena	39.6%	34.1%	16.5%	8.5%	1.3%	6516
Cartago	35.5%	39.6%	14.8%	8.7%	1.3%	608
Casanare	38.2%	38.0%	14.9%	7.6%	1.3%	1433
Cauca	41.7%	32.9%	15.7%	8.3%	1.4%	5696
Cesar	41.5%	33.3%	16.3%	8.4%	0.6%	3686
Chocó	41.5%	27.2%	16.4%	13.1%	1.8%	1417
Chía	30.5%	45.4%	15.4%	8.2%	0.4%	971
Ciénaga	38.8%	34.7%	17.1%	9.1%	0.3%	747

Continúa en la siguiente página

GRADO 9° - MATEMÁTICAS

ETC/País	A	B	C	D	Omisión y multimarca	N° estudiantes
Cundinamarca	36.4%	39.2%	15.8%	7.8%	0.7%	9588
Córdoba	41.4%	30.8%	17.1%	9.7%	1.0%	6073
Cúcuta	36.4%	40.9%	15.8%	6.5%	0.3%	4355
Dosquebradas	34.8%	38.8%	16.0%	9.3%	1.1%	931
Duitama	30.2%	47.0%	13.7%	8.2%	0.9%	951
Envigado	28.0%	46.5%	16.6%	8.1%	0.8%	1332
Facatativá	33.4%	40.7%	16.9%	8.7%	0.3%	791
Florencia	40.7%	33.0%	17.5%	7.9%	0.9%	932
Floridablanca	33.0%	44.2%	14.7%	7.3%	0.8%	1551
Fusagasugá	34.4%	42.0%	15.9%	6.8%	0.8%	854
Girardot	38.3%	35.2%	16.4%	8.8%	1.4%	731
Girón	35.1%	40.5%	15.5%	8.1%	0.8%	716
Guainía	50.0%	0.0%	0.0%	50.0%	0.0%	2
Guaviare	39.6%	32.1%	17.2%	9.3%	1.8%	495
Huila	39.7%	36.6%	16.2%	6.9%	0.6%	4000
Ibagué	35.7%	38.3%	16.8%	8.3%	0.8%	3313
Ipiales	36.7%	41.2%	14.5%	6.3%	1.2%	725
Itagüí	36.1%	35.5%	15.9%	11.0%	1.4%	1267
Jamundí	39.9%	34.6%	15.4%	9.1%	1.0%	684
La Guajira	41.0%	32.5%	16.6%	8.4%	1.5%	1358
Lorica	38.3%	31.7%	19.3%	9.7%	1.0%	931
Magangué	44.2%	34.4%	14.0%	6.5%	0.9%	751
Magdalena	45.1%	27.8%	16.6%	9.2%	1.3%	3737
Maicao	41.4%	31.4%	17.2%	8.2%	1.8%	850
Malambo	38.0%	37.3%	16.0%	7.1%	1.6%	563
Manizales	35.9%	39.7%	15.9%	7.8%	0.7%	2369
Medellín	35.2%	37.6%	17.1%	9.1%	1.0%	13275
Meta	37.9%	36.1%	15.9%	8.9%	1.3%	2478
Montería	40.4%	34.8%	14.8%	8.4%	1.7%	2840
Mosquera	33.2%	41.4%	16.1%	9.1%	0.3%	771
Nariño	39.9%	35.8%	14.7%	7.6%	2.0%	4306
Neiva	38.0%	38.0%	15.9%	7.6%	0.5%	2436
Norte de Santander	38.6%	36.4%	16.9%	7.4%	0.7%	3660
Palmira	34.5%	39.2%	17.7%	7.8%	0.8%	1677
Pasto	35.3%	40.6%	15.3%	8.1%	0.7%	2706
Pereira	35.8%	38.2%	18.0%	7.3%	0.7%	2789
Piedecuesta	30.1%	44.2%	15.4%	9.5%	0.8%	855
Pitalito	39.8%	35.9%	14.3%	10.0%	0.0%	763
Popayán	38.8%	35.3%	16.7%	7.5%	1.7%	1832

Continúa en la siguiente página



ETC/País	A	B	C	D	Omisión y multimarca	N° estudiantes
Putumayo	38.9%	34.3%	17.5%	8.5%	0.8%	1989
Quibdó	37.8%	29.2%	19.7%	10.1%	3.2%	878
Quindío	39.0%	35.6%	17.2%	7.6%	0.5%	1688
Riohacha	38.6%	35.0%	15.9%	8.8%	1.8%	958
Rionegro	33.6%	40.8%	15.8%	8.8%	1.0%	830
Risaralda	41.9%	34.2%	15.0%	8.4%	0.5%	1501
Sabaneta	28.4%	49.1%	13.5%	8.5%	0.5%	377
Sahagún	41.2%	33.8%	16.6%	8.0%	0.5%	791
San Andrés	36.2%	30.5%	19.8%	10.2%	3.4%	354
Santa Marta	38.8%	33.9%	17.4%	8.6%	1.3%	2899
Santander	38.6%	38.0%	15.1%	7.7%	0.6%	4612
Sincelejo	41.9%	33.5%	17.0%	6.9%	0.7%	2119
Soacha	37.1%	39.7%	15.1%	7.6%	0.5%	3300
Sogamoso	35.5%	40.2%	16.4%	7.6%	0.3%	964
Soledad	39.6%	36.0%	16.1%	7.4%	1.0%	2583
Sucre	40.5%	31.8%	17.7%	9.3%	0.7%	3938
Tolima	40.5%	34.7%	16.5%	7.7%	0.7%	5129
Tuluá	37.9%	35.2%	17.2%	9.1%	0.5%	1315
Tumaco	40.7%	29.2%	18.2%	9.7%	2.1%	872
Tunja	34.5%	44.3%	13.1%	7.7%	0.5%	1175
Turbo	41.0%	30.3%	16.2%	10.9%	1.5%	804
Uribe	51.0%	28.2%	14.1%	6.7%	0.0%	149
Valle del Cauca	40.5%	34.5%	16.0%	7.9%	1.1%	4706
Valledupar	40.0%	34.0%	17.2%	7.7%	1.1%	2690
Vaupés	0.0%	25.0%	0.0%	25.0%	50.0%	4
Vichada	39.7%	31.0%	15.7%	11.4%	2.2%	229
Villavicencio	36.8%	39.4%	15.8%	7.3%	0.7%	3070
Yopal	36.4%	40.6%	15.8%	6.7%	0.5%	988
Yumbo	35.3%	39.3%	17.2%	7.7%	0.4%	737
Zipaquirá	34.5%	44.2%	13.5%	7.4%	0.4%	852
Colombia	37.1%	37.5%	16.1%	8.1%	1.3%	275336

*Es posible que los porcentajes mostrados no sumen exactamente 100 debido a aproximaciones decimales.

• **Pregunta 21.**

Andrés y David están entrenando para un campeonato de pimpón. En la siguiente tabla aparece el ganador de cada uno de los últimos 10 partidos jugados entre ellos.

Juego	Ganador
1	Andrés
2	Andrés
3	David
4	David
5	David
6	Andrés
7	David
8	Andrés
9	David
10	David

De acuerdo con la información de la tabla, ¿cuál es la observación de mayor probabilidad con respecto al ganador en estos 10 juegos?

- A. David, porque ganó los 2 últimos juegos.
- B. Andrés, porque ganó los 2 primeros juegos.
- C. David, porque ganó 6 de 10 juegos.
- D. Andrés, porque ganó 4 de 10 juegos.

• **Estructura**

Competencia	Razonamiento y argumentación
Componente	Aleatorio
Afirmación	Utilizar diferentes métodos y estrategias para calcular la probabilidad de eventos simples
Nivel de desempeño	Mínimo
Respuesta Correcta	C

• Resultados a nivel nacional y de Entidad Territorial Certificada (ETC)

ETC/País	A	B	C	D	Omisión y multimarca	N° estudiantes
Amazonas	11.0%	6.1%	80.0%	2.7%	0.2%	410
Antioquia	8.1%	4.6%	83.8%	2.9%	0.6%	13194
Apartadó	9.9%	8.5%	78.4%	3.1%	0.1%	779
Arauca	7.3%	3.2%	85.2%	3.8%	0.5%	1239
Armenia	7.8%	4.0%	85.9%	2.0%	0.3%	1846
Atlántico	9.8%	4.1%	80.6%	5.3%	0.3%	3385
Barrancabermeja	8.3%	4.2%	83.9%	3.2%	0.4%	1305
Barranquilla	8.0%	4.2%	84.6%	2.5%	0.7%	6501
Bello	7.7%	5.4%	84.1%	2.6%	0.3%	2366
Bogotá, D.C.	6.9%	3.3%	85.3%	2.2%	2.3%	46573
Bolívar	10.6%	5.2%	79.4%	4.1%	0.7%	5373
Boyacá	8.2%	4.5%	84.8%	2.1%	0.3%	5615
Bucaramanga	6.5%	3.2%	88.5%	1.7%	0.1%	3743
Buenaventura	9.6%	5.9%	79.3%	3.9%	1.3%	1742
Buga	8.3%	2.7%	83.9%	2.7%	2.4%	635
Caldas	7.0%	4.1%	85.5%	3.0%	0.4%	3340
Cali	7.7%	3.9%	84.4%	2.8%	1.3%	12346
Caquetá	9.8%	5.2%	81.5%	3.1%	0.4%	1125
Cartagena	9.0%	4.7%	82.7%	3.1%	0.6%	6521
Cartago	7.2%	2.8%	87.2%	2.1%	0.7%	608
Casanare	7.9%	4.0%	85.2%	2.2%	0.7%	1435
Cauca	8.3%	4.2%	83.3%	3.7%	0.6%	5697
Cesar	8.3%	4.8%	82.9%	3.8%	0.1%	3688
Chocó	11.5%	5.7%	77.4%	4.5%	0.9%	1409
Chía	7.8%	2.1%	88.4%	1.5%	0.2%	971
Ciénaga	8.7%	5.1%	83.8%	2.1%	0.3%	747
Cundinamarca	6.4%	3.7%	86.9%	2.5%	0.4%	9587
Córdoba	9.7%	5.7%	79.8%	4.1%	0.8%	6076
Cúcuta	7.5%	3.9%	86.4%	1.8%	0.3%	4355
Dosquebradas	6.4%	4.2%	87.0%	1.8%	0.5%	931
Duitama	6.8%	3.0%	87.6%	1.9%	0.6%	951
Envigado	7.4%	2.9%	87.6%	1.9%	0.2%	1332
Facatativá	7.6%	4.6%	85.7%	2.2%	0.0%	790
Florencia	7.6%	3.4%	85.5%	2.8%	0.6%	933
Floridablanca	8.1%	3.0%	86.8%	1.7%	0.5%	1552
Fusagasugá	7.3%	3.3%	87.7%	1.5%	0.2%	854
Girardot	8.3%	4.7%	83.2%	3.1%	0.7%	731

Continúa en la siguiente página

GRADO 9° - MATEMÁTICAS

ETC/País	A	B	C	D	Omisión y multimarca	N° estudiantes
Girón	6.6%	3.9%	86.9%	2.1%	0.6%	715
Guainía	0.0%	0.0%	100.0%	0.0%	0.0%	2
Guaviare	7.7%	3.2%	84.4%	2.8%	1.8%	495
Huila	7.1%	4.3%	85.8%	2.6%	0.2%	4002
Ibagué	6.5%	3.8%	86.8%	2.5%	0.5%	3312
Ipiales	7.1%	4.0%	85.8%	2.8%	0.4%	723
Itagüí	10.0%	5.8%	80.9%	2.4%	1.0%	1269
Jamundí	7.5%	3.2%	85.7%	3.2%	0.4%	684
La Guajira	10.4%	5.2%	79.1%	3.8%	1.5%	1356
Lorica	12.1%	5.0%	76.9%	5.4%	0.5%	931
Magangué	9.2%	6.1%	80.2%	4.0%	0.5%	752
Magdalena	9.9%	4.8%	81.2%	3.6%	0.5%	3733
Maicao	8.5%	4.9%	82.2%	2.9%	1.4%	850
Malambo	8.8%	5.2%	81.4%	4.5%	0.2%	559
Manizales	7.8%	3.3%	86.0%	2.6%	0.3%	2372
Medellín	7.9%	4.6%	84.3%	2.5%	0.7%	13276
Meta	7.6%	4.7%	84.8%	2.3%	0.7%	2485
Montería	8.9%	4.6%	82.4%	3.0%	1.1%	2838
Mosquera	7.8%	3.2%	85.8%	3.0%	0.3%	773
Nariño	7.7%	4.2%	83.7%	2.9%	1.5%	4307
Neiva	7.1%	4.3%	85.8%	2.7%	0.2%	2436
Norte de Santander	8.2%	4.4%	84.5%	2.5%	0.4%	3655
Palmira	7.2%	3.8%	85.5%	2.9%	0.7%	1675
Pasto	6.0%	3.4%	88.0%	2.2%	0.3%	2702
Pereira	7.5%	3.3%	85.8%	2.5%	0.8%	2788
Piedecuesta	6.4%	4.0%	86.7%	2.5%	0.5%	855
Pitalito	6.3%	3.8%	87.5%	2.5%	0.0%	765
Popayán	5.6%	3.2%	87.8%	2.5%	0.9%	1835
Putumayo	7.5%	4.1%	85.1%	2.8%	0.5%	1990
Quibdó	9.0%	5.1%	79.1%	4.1%	2.7%	879
Quindío	7.9%	4.4%	85.0%	2.6%	0.1%	1688
Riohacha	9.5%	5.8%	80.9%	3.3%	0.4%	959
Rionegro	6.6%	3.5%	87.0%	2.7%	0.2%	830
Risaralda	6.4%	3.6%	87.0%	2.7%	0.3%	1502
Sabaneta	4.8%	2.1%	89.1%	3.4%	0.5%	377
Sahagún	8.2%	5.8%	81.8%	3.9%	0.3%	791
San Andrés	10.7%	5.6%	78.5%	3.7%	1.4%	354
Santa Marta	9.0%	4.3%	82.9%	3.2%	0.7%	2901
Santander	7.0%	3.4%	86.9%	2.4%	0.3%	4609

Continúa en la siguiente página



ETC/País	A	B	C	D	Omisión y multimarca	N° estudiantes
Sincelejo	8.3%	4.6%	84.4%	2.5%	0.2%	2119
Soacha	7.9%	3.4%	85.9%	2.4%	0.3%	3301
Sogamoso	7.2%	4.3%	87.0%	1.6%	0.0%	964
Soledad	8.4%	4.3%	84.4%	2.6%	0.3%	2582
Sucre	10.0%	5.8%	80.0%	3.7%	0.5%	3941
Tolima	8.7%	4.8%	83.1%	3.1%	0.3%	5128
Tuluá	7.8%	4.5%	84.0%	3.4%	0.2%	1315
Tumaco	11.2%	4.8%	80.6%	3.0%	0.3%	872
Tunja	7.2%	3.7%	85.6%	2.6%	0.8%	1177
Turbo	10.0%	5.3%	78.7%	4.6%	1.4%	804
Uribe	8.7%	4.7%	83.9%	2.7%	0.0%	149
Valle del Cauca	7.7%	4.1%	84.2%	3.3%	0.7%	4711
Valledupar	8.7%	4.1%	84.2%	2.2%	0.8%	2687
Vaupés	0.0%	0.0%	50.0%	0.0%	50.0%	4
Vichada	7.4%	3.1%	85.2%	3.9%	0.4%	229
Villavicencio	6.8%	4.2%	86.0%	2.5%	0.5%	3070
Yopal	6.4%	2.9%	88.4%	2.1%	0.1%	987
Yumbo	8.0%	2.3%	86.4%	3.1%	0.1%	737
Zipacquirá	5.9%	3.2%	89.0%	2.0%	0.0%	852
Colombia	7.9%	4.1%	84.4%	2.8%	0.9%	275339

*Es posible que los porcentajes mostrados no sumen exactamente 100 debido a aproximaciones decimales.

 Responde las preguntas 22 y 23 de acuerdo con la siguiente información:

Observa la secuencia:

$$\begin{array}{ll}
 \text{Fila 1.} & 1 + 3 = 4 \\
 \text{Fila 2.} & 1 + 3 + 5 = 9 \\
 \cdot & \cdot \\
 \cdot & \cdot \\
 \cdot & \cdot \\
 \text{Fila 5.} & 1 + 3 + 5 + 7 + 9 + 11 = ?
 \end{array}$$

• **Pregunta 22.**

¿Cuál es el resultado de la suma de los términos de la fila 5 ?

- A. 5^2
- B. 6^2
- C. 10^2
- D. 11^2

• **Estructura**

Competencia	Razonamiento y argumentación
Componente	Numérico - variacional
Afirmación	Identificar y describir las relaciones (aditivas, multiplicativas, de recurrencia...) que se pueden establecer en una secuencia numérica.
Nivel de desempeño	Mínimo
Respuesta Correcta	B

• Resultados a nivel nacional y de Entidad Territorial Certificada (ETC)

ETC/País	A	B	C	D	Omisión y multimarca	N° estudiantes
Amazonas	4.6%	58.0%	10.2%	25.6%	1.5%	410
Antioquia	4.7%	69.3%	6.6%	18.4%	0.9%	13194
Apartadó	8.5%	63.9%	7.8%	19.0%	0.8%	779
Arauca	5.2%	75.9%	5.8%	11.9%	1.1%	1239
Armenia	4.4%	75.0%	6.2%	13.8%	0.7%	1846
Atlántico	6.6%	58.7%	8.9%	24.7%	1.0%	3385
Barrancabermeja	3.5%	71.5%	6.9%	17.5%	0.5%	1305
Barranquilla	5.1%	74.7%	6.2%	12.8%	1.2%	6501
Bello	5.4%	71.2%	7.7%	15.1%	0.7%	2366
Bogotá, D.C.	3.6%	76.5%	4.8%	12.2%	2.7%	46573
Bolívar	5.9%	59.2%	9.1%	24.5%	1.3%	5373
Boyacá	3.6%	76.2%	5.5%	14.2%	0.5%	5615
Bucaramanga	3.3%	86.2%	3.2%	6.9%	0.4%	3743
Buenaventura	5.5%	60.7%	9.5%	22.7%	1.7%	1742
Buga	4.4%	67.7%	7.2%	18.0%	2.7%	635
Caldas	4.4%	73.1%	6.2%	15.8%	0.5%	3340
Cali	4.4%	73.7%	6.5%	13.6%	1.9%	12346
Caquetá	5.2%	75.0%	5.8%	13.3%	0.6%	1125
Cartagena	5.6%	66.6%	7.3%	19.0%	1.5%	6521
Cartago	3.6%	76.6%	4.8%	14.1%	0.8%	608
Casanare	2.9%	78.5%	4.9%	12.8%	0.8%	1435
Cauca	4.3%	72.8%	6.4%	15.4%	1.0%	5697
Cesar	5.2%	68.6%	7.6%	18.1%	0.5%	3688
Chocó	7.4%	57.0%	9.3%	25.1%	1.2%	1409
Chía	3.5%	83.5%	2.8%	9.8%	0.4%	971
Ciénaga	7.4%	59.2%	9.6%	23.0%	0.8%	747
Cundinamarca	3.9%	76.4%	5.4%	13.6%	0.8%	9587
Córdoba	6.5%	61.0%	8.7%	22.7%	1.1%	6076
Cúcuta	3.6%	77.3%	5.5%	13.0%	0.6%	4355
Dosquebradas	3.1%	79.8%	4.1%	12.5%	0.5%	931
Duitama	3.7%	85.6%	2.7%	7.8%	0.2%	951
Envigado	3.8%	82.8%	3.1%	9.8%	0.6%	1332
Facatativá	3.0%	77.7%	5.2%	13.8%	0.3%	790
Florencia	4.8%	74.8%	6.2%	13.1%	1.1%	933
Floridablanca	3.7%	83.7%	3.8%	8.2%	0.6%	1552
Fusagasugá	4.0%	75.4%	6.4%	13.6%	0.6%	854
Girardot	7.1%	66.8%	8.6%	16.0%	1.5%	731

Continúa en la siguiente página

GRADO 9° - MATEMÁTICAS

ETC/País	A	B	C	D	Omisión y multimarca	N° estudiantes
Girón	4.5%	79.2%	4.8%	10.8%	0.8%	715
Guainía	0.0%	0.0%	0.0%	100.0%	0.0%	2
Guaviare	6.1%	70.7%	5.9%	15.4%	2.0%	495
Huila	3.9%	73.8%	6.5%	15.3%	0.4%	4002
Ibagué	3.4%	77.6%	5.1%	13.0%	0.9%	3312
Ipiales	3.3%	85.2%	4.7%	5.8%	1.0%	723
Itagüí	5.9%	69.1%	8.0%	15.6%	1.4%	1269
Jamundí	4.7%	65.9%	8.2%	20.2%	1.0%	684
La Guajira	6.0%	66.5%	7.3%	18.5%	1.7%	1356
Lorica	6.7%	58.3%	9.8%	24.6%	0.6%	931
Magangué	5.9%	64.8%	8.2%	19.5%	1.6%	752
Magdalena	6.7%	60.2%	8.3%	24.1%	0.6%	3733
Maicao	7.1%	61.1%	9.1%	21.3%	1.5%	850
Malambo	7.2%	62.1%	8.8%	20.9%	1.1%	559
Manizales	3.8%	78.0%	5.2%	12.6%	0.5%	2372
Medellín	4.8%	72.1%	6.5%	15.4%	1.2%	13276
Meta	4.0%	72.2%	6.6%	16.4%	0.9%	2485
Montería	4.8%	67.2%	7.3%	19.3%	1.4%	2838
Mosquera	3.1%	78.5%	6.0%	12.4%	0.0%	773
Nariño	3.7%	80.9%	4.4%	9.2%	1.8%	4307
Neiva	4.2%	77.8%	5.5%	11.9%	0.6%	2436
Norte de Santander	3.7%	78.8%	5.3%	11.5%	0.6%	3655
Palmira	4.1%	76.8%	5.5%	12.5%	1.1%	1675
Pasto	4.1%	83.1%	4.0%	8.0%	0.7%	2702
Pereira	3.8%	79.4%	4.9%	11.2%	0.8%	2788
Piedecuesta	5.6%	82.8%	2.9%	8.2%	0.5%	855
Pitalito	4.3%	80.1%	5.2%	9.9%	0.4%	765
Popayán	3.4%	85.6%	3.3%	6.5%	1.1%	1835
Putumayo	3.5%	80.5%	4.5%	10.7%	0.9%	1990
Quibdó	7.3%	57.7%	8.3%	23.9%	2.8%	879
Quindío	4.7%	70.8%	6.2%	17.8%	0.5%	1688
Riohacha	6.0%	65.1%	9.1%	19.0%	0.8%	959
Rionegro	3.1%	75.9%	5.1%	15.7%	0.2%	830
Risaralda	3.5%	74.8%	6.1%	15.0%	0.6%	1502
Sabaneta	3.4%	80.9%	3.2%	11.9%	0.5%	377
Sahagún	7.5%	61.4%	6.8%	23.1%	1.1%	791
San Andrés	4.8%	63.3%	9.0%	20.9%	2.0%	354
Santa Marta	5.9%	67.5%	7.8%	17.5%	1.3%	2901
Santander	4.0%	79.7%	4.5%	11.4%	0.4%	4609

Continúa en la siguiente página

ETC/País	A	B	C	D	Omisión y multimarca	N° estudiantes
Sincelejo	4.6%	70.7%	8.5%	15.8%	0.3%	2119
Soacha	3.9%	73.7%	5.8%	15.9%	0.8%	3301
Sogamoso	1.9%	84.4%	3.6%	9.9%	0.2%	964
Soledad	4.9%	71.1%	7.1%	16.0%	0.9%	2582
Sucre	6.3%	64.1%	7.8%	20.9%	0.8%	3941
Tolima	5.7%	67.5%	7.6%	18.4%	0.8%	5128
Tuluá	4.1%	67.5%	8.0%	20.0%	0.5%	1315
Tumaco	5.2%	68.0%	7.1%	18.9%	0.8%	872
Tunja	4.2%	78.4%	4.5%	11.9%	0.9%	1177
Turbo	6.8%	50.4%	8.6%	32.3%	1.9%	804
Uribe	6.0%	53.7%	10.7%	28.9%	0.7%	149
Valle del Cauca	5.3%	66.8%	7.6%	19.0%	1.3%	4711
Valledupar	5.1%	63.9%	8.2%	21.7%	1.2%	2687
Vaupés	0.0%	50.0%	0.0%	0.0%	50.0%	4
Vichada	6.1%	70.7%	6.1%	16.6%	0.4%	229
Villavicencio	3.6%	79.8%	5.1%	10.7%	0.8%	3070
Yopal	4.1%	77.5%	5.5%	12.0%	1.0%	987
Yumbo	5.0%	68.4%	7.3%	18.6%	0.7%	737
Zipacquirá	3.1%	82.0%	4.2%	10.0%	0.7%	852
Colombia	4.5%	72.9%	6.2%	15.2%	1.3%	275339

*Es posible que los porcentajes mostrados no sumen exactamente 100 debido a aproximaciones decimales.

• Pregunta 23.

¿Cuál es el mayor sumando de la fila 4 ?

- A. 4
- B. 7
- C. 9
- D. 11

• Estructura

Competencia	Comunicación, representación y modelación
Componente	Numérico - variacional
Afirmación	Reconocer el lenguaje algebraico como forma de representar procesos inductivos.
Nivel de desempeño	Satisfactorio
Respuesta Correcta	C

• Resultados a nivel nacional y de Entidad Territorial Certificada (ETC)

ETC/País	A	B	C	D	Omisión y multimarca	Nº estudiantes
Amazonas	7.6%	21.7%	40.2%	28.0%	2.4%	410
Antioquia	8.4%	18.1%	50.2%	22.0%	1.3%	13194
Apartadó	11.7%	18.1%	49.0%	19.9%	1.3%	779
Arauca	7.8%	16.5%	55.8%	18.3%	1.6%	1239
Armenia	5.6%	16.8%	57.9%	18.5%	1.1%	1846
Atlántico	9.1%	18.3%	44.0%	26.9%	1.6%	3385
Barrancabermeja	7.8%	16.9%	57.5%	16.8%	0.9%	1305
Barranquilla	7.0%	16.2%	56.2%	18.9%	1.8%	6501
Bello	8.9%	18.4%	54.1%	17.7%	0.8%	2366
Bogotá, D.C.	3.9%	14.0%	65.7%	13.6%	2.9%	46573
Bolívar	10.7%	18.3%	42.3%	26.8%	1.9%	5373
Boyacá	6.8%	16.7%	57.5%	18.2%	0.8%	5615
Bucaramanga	4.1%	13.0%	69.8%	12.3%	0.8%	3743
Buenaventura	9.2%	17.9%	42.3%	28.1%	2.5%	1742
Buga	7.6%	16.7%	56.7%	16.2%	2.8%	635
Caldas	8.5%	19.0%	50.0%	21.7%	0.8%	3340
Cali	5.9%	16.1%	57.3%	18.2%	2.4%	12346
Caquetá	8.4%	19.8%	47.6%	23.1%	1.2%	1125
Cartagena	7.7%	17.3%	53.0%	20.3%	1.8%	6521
Cartago	6.4%	14.6%	58.7%	19.1%	1.2%	608
Casanare	7.1%	17.8%	55.7%	18.7%	0.8%	1435
Cauca	9.5%	16.1%	45.4%	26.7%	2.2%	5697
Cesar	9.5%	17.7%	46.1%	25.5%	1.2%	3688
Chocó	12.7%	16.7%	32.3%	36.6%	1.6%	1409
Chía	3.1%	13.5%	70.9%	12.3%	0.3%	971
Ciénaga	9.9%	15.1%	44.8%	28.5%	1.6%	747
Cundinamarca	6.1%	15.9%	60.2%	16.7%	1.1%	9587
Córdoba	11.0%	18.3%	41.2%	27.8%	1.7%	6076
Cúcuta	6.4%	16.0%	60.6%	16.2%	0.8%	4355
Dosquebradas	6.2%	14.9%	59.8%	17.9%	1.1%	931
Duitama	3.3%	13.1%	73.0%	10.4%	0.2%	951
Envigado	3.2%	13.9%	68.6%	13.2%	1.1%	1332
Facatativá	5.4%	16.1%	63.9%	13.2%	1.4%	790
Florencia	7.1%	14.7%	55.0%	22.0%	1.3%	933
Floridablanca	4.3%	13.7%	67.8%	13.5%	0.8%	1552
Fusagasugá	5.6%	17.6%	59.8%	15.9%	1.1%	854
Girardot	7.0%	16.6%	52.0%	22.4%	2.1%	731

Continúa en la siguiente página

GRADO 9° - MATEMÁTICAS

ETC/País	A	B	C	D	Omisión y multimarca	N° estudiantes
Girón	4.6%	15.0%	62.2%	17.1%	1.1%	715
Guainía	50.0%	50.0%	0.0%	0.0%	0.0%	2
Guaviare	6.7%	14.7%	49.5%	26.1%	3.0%	495
Huila	6.7%	17.2%	53.3%	22.0%	0.7%	4002
Ibagué	6.0%	16.4%	60.2%	15.9%	1.5%	3312
Ipiales	5.7%	13.7%	59.9%	19.2%	1.5%	723
Itagüí	6.3%	17.2%	54.8%	19.5%	2.1%	1269
Jamundí	7.6%	19.7%	49.4%	21.6%	1.6%	684
La Guajira	9.8%	15.9%	47.3%	24.8%	2.2%	1356
Lorica	10.5%	17.4%	38.5%	32.2%	1.4%	931
Magangué	9.2%	16.5%	43.4%	29.0%	2.0%	752
Magdalena	12.5%	16.8%	39.9%	29.3%	1.5%	3733
Maicao	10.8%	20.2%	39.9%	26.5%	2.6%	850
Malambo	8.2%	18.1%	48.5%	23.3%	2.0%	559
Manizales	6.1%	18.4%	57.4%	17.3%	0.8%	2372
Medellín	6.7%	16.4%	57.2%	18.1%	1.6%	13276
Meta	7.8%	17.3%	53.1%	20.4%	1.4%	2485
Montería	7.8%	16.7%	51.3%	22.0%	2.1%	2838
Mosquera	5.0%	13.8%	65.3%	15.0%	0.8%	773
Nariño	7.6%	17.3%	51.4%	21.0%	2.7%	4307
Neiva	5.8%	15.8%	59.7%	18.0%	0.7%	2436
Norte de Santander	7.6%	16.5%	54.7%	20.3%	0.9%	3655
Palmira	5.1%	14.9%	61.7%	16.8%	1.4%	1675
Pasto	4.4%	16.1%	62.4%	16.2%	0.9%	2702
Pereira	6.7%	16.4%	58.5%	17.2%	1.2%	2788
Piedecuesta	4.6%	15.8%	65.5%	13.6%	0.6%	855
Pitalito	5.5%	17.3%	55.7%	20.8%	0.8%	765
Popayán	5.3%	14.8%	60.8%	17.1%	2.1%	1835
Putumayo	6.5%	16.5%	54.3%	21.0%	1.7%	1990
Quibdó	10.8%	16.5%	38.8%	30.1%	3.8%	879
Quindío	6.5%	17.1%	52.9%	22.6%	0.8%	1688
Riohacha	9.6%	17.0%	44.9%	27.4%	1.0%	959
Rionegro	5.7%	14.5%	63.0%	16.4%	0.5%	830
Risaralda	8.5%	17.2%	50.5%	22.9%	0.9%	1502
Sabaneta	2.7%	12.5%	70.0%	13.8%	1.1%	377
Sahagún	11.4%	17.8%	44.2%	24.8%	1.8%	791
San Andrés	8.5%	15.0%	50.3%	23.4%	2.8%	354
Santa Marta	8.9%	16.0%	51.0%	22.5%	1.7%	2901
Santander	6.2%	15.8%	59.0%	18.3%	0.7%	4609

Continúa en la siguiente página



ETC/País	A	B	C	D	Omisión y multimarca	N° estudiantes
Sincelejo	7.4%	17.3%	52.8%	21.3%	1.2%	2119
Soacha	5.5%	16.7%	61.2%	15.7%	1.0%	3301
Sogamoso	5.4%	14.0%	67.6%	12.8%	0.2%	964
Soledad	6.9%	16.7%	54.4%	20.6%	1.5%	2582
Sucre	10.0%	18.1%	43.7%	26.6%	1.6%	3941
Tolima	9.2%	18.4%	47.4%	23.7%	1.2%	5128
Tuluá	8.4%	17.3%	54.1%	19.2%	1.1%	1315
Tumaco	9.7%	16.6%	40.0%	32.1%	1.5%	872
Tunja	4.8%	14.4%	64.5%	15.0%	1.4%	1177
Turbo	11.2%	17.0%	38.7%	29.7%	3.4%	804
Uribe	8.1%	21.5%	38.3%	30.9%	1.3%	149
Valle del Cauca	7.9%	18.7%	48.9%	22.8%	1.6%	4711
Valledupar	8.9%	18.3%	48.8%	22.3%	1.8%	2687
Vaupés	0.0%	0.0%	25.0%	25.0%	50.0%	4
Vichada	8.3%	18.8%	45.9%	26.2%	0.9%	229
Villavicencio	5.0%	14.8%	62.5%	16.9%	0.7%	3070
Yopal	4.5%	15.1%	64.9%	15.0%	0.5%	987
Yumbo	7.6%	16.1%	56.0%	18.9%	1.4%	737
Zipaquirá	3.9%	12.1%	72.3%	11.0%	0.7%	852
Colombia	6.9%	16.3%	55.8%	19.4%	1.7%	275339

*Es posible que los porcentajes mostrados no sumen exactamente 100 debido a aproximaciones decimales.

 Responde las preguntas 24 y 25 de acuerdo con la siguiente información:

En la siguiente tabla se muestra la marca, el precio por litro y la cantidad de litros de helado vendidos por un distribuidor en cuatro tiendas distintas.

MARCA	PRECIO POR LITRO	TIENDA 1	TIENDA 2	TIENDA 3	TIENDA 4
El Fresco	\$5.000	10 litros	9 litros	6 litros	7 litros
Hela 2	\$4.500	9 litros	8 litros	9 litros	9 litros
Delicioso	\$3.500	8 litros	4 litros	8 litros	9 litros
San Alberto	\$6.500	4 litros	8 litros	7 litros	6 litros

• Pregunta 24.

¿Cuál es la marca de helado que más ha vendido el distribuidor en estas cuatro tiendas?

- A. El Fresco
- B. Hela 2
- C. Delicioso
- D. San Alberto

• Estructura

Competencia	Comunicación, representación y modelación
Componente	Aleatorio
Afirmación	Comparar, usar e interpretar datos que provienen de situaciones reales y traducir entre diferentes representaciones de un conjunto de datos.
Nivel de desempeño	Mínimo
Respuesta Correcta	B

• **Resultados a nivel nacional y de Entidad Territorial Certificada (ETC)**

ETC/País	A	B	C	D	Omisión y multimarca	N° estudiantes
Amazonas	27.3%	51.2%	5.6%	13.9%	2.0%	410
Antioquia	22.1%	63.6%	3.5%	9.6%	1.2%	13194
Apartadó	18.5%	59.8%	5.8%	15.8%	0.1%	779
Arauca	20.1%	67.5%	3.0%	8.2%	1.2%	1239
Armenia	22.3%	64.1%	3.4%	9.3%	1.0%	1846
Atlántico	24.5%	56.5%	4.8%	13.2%	1.0%	3385
Barrancabermeja	21.5%	62.7%	3.9%	11.0%	1.0%	1305
Barranquilla	21.8%	62.7%	3.1%	10.8%	1.6%	6501
Bello	23.5%	63.3%	3.6%	8.4%	1.2%	2366
Bogotá, D.C.	21.3%	65.0%	2.3%	8.7%	2.8%	46573
Bolívar	23.0%	55.6%	4.6%	15.3%	1.6%	5373
Boyacá	20.2%	65.7%	2.9%	10.3%	0.9%	5615
Bucaramanga	17.2%	73.1%	2.1%	7.2%	0.4%	3743
Buenaventura	21.8%	57.4%	3.0%	15.9%	1.9%	1742
Buga	22.0%	63.8%	3.0%	8.3%	2.8%	635
Caldas	21.8%	64.5%	3.1%	10.0%	0.7%	3340
Cali	21.8%	62.6%	3.2%	10.5%	1.8%	12346
Caquetá	20.5%	64.2%	2.9%	11.5%	0.9%	1125
Cartagena	23.9%	58.7%	3.5%	12.6%	1.3%	6521
Cartago	24.8%	61.8%	2.0%	9.7%	1.6%	608
Casanare	21.0%	64.2%	2.8%	11.1%	0.9%	1435
Cauca	22.5%	58.9%	3.3%	14.0%	1.4%	5697
Cesar	21.4%	63.0%	3.3%	11.5%	0.8%	3688
Chocó	22.4%	52.0%	6.3%	18.0%	1.3%	1409
Chía	18.1%	69.8%	1.5%	9.8%	0.7%	971
Ciénaga	24.1%	61.0%	4.7%	9.4%	0.8%	747
Cundinamarca	21.6%	66.1%	2.4%	8.9%	0.9%	9587
Córdoba	23.4%	57.7%	4.8%	12.6%	1.5%	6076
Cúcuta	20.1%	68.0%	2.8%	8.4%	0.7%	4355
Dosquebradas	21.8%	66.2%	3.1%	7.7%	1.2%	931
Duitama	15.8%	73.6%	2.6%	7.4%	0.6%	951
Envigado	18.1%	69.5%	3.2%	8.2%	1.0%	1332
Facatativá	20.0%	68.0%	3.5%	8.4%	0.1%	790
Florencia	18.0%	66.7%	2.8%	11.7%	0.9%	933
Floridablanca	18.5%	72.5%	2.3%	5.7%	1.0%	1552
Fusagasugá	24.0%	63.9%	2.3%	8.5%	1.2%	854
Girardot	21.9%	61.1%	1.8%	13.8%	1.4%	731

Continúa en la siguiente página

GRADO 9° - MATEMÁTICAS

ETC/País	A	B	C	D	Omisión y multimarca	N° estudiantes
Girón	19.4%	71.7%	1.0%	6.9%	1.0%	715
Guainía	0.0%	0.0%	100.0%	0.0%	0.0%	2
Guaviare	20.0%	62.6%	2.2%	12.7%	2.4%	495
Huila	21.3%	64.5%	2.5%	11.0%	0.8%	4002
Ibagué	22.2%	66.5%	2.6%	7.7%	1.0%	3312
Ipiales	22.1%	63.9%	2.4%	10.8%	0.8%	723
Itagüí	21.8%	62.5%	3.6%	10.6%	1.5%	1269
Jamundí	25.6%	60.2%	3.4%	10.1%	0.7%	684
La Guajira	19.5%	61.7%	4.1%	12.0%	2.7%	1356
Lorica	27.2%	55.1%	4.8%	12.1%	0.8%	931
Magangué	24.6%	58.9%	3.9%	11.8%	0.8%	752
Magdalena	24.1%	57.3%	4.4%	13.3%	0.9%	3733
Maicao	23.4%	58.0%	3.4%	12.5%	2.7%	850
Malambo	22.2%	61.2%	3.9%	11.8%	0.9%	559
Manizales	22.4%	64.5%	3.4%	8.7%	1.0%	2372
Medellín	22.5%	64.2%	3.4%	8.7%	1.3%	13276
Meta	20.3%	65.1%	3.3%	10.3%	1.1%	2485
Montería	23.2%	61.1%	3.8%	10.3%	1.6%	2838
Mosquera	24.2%	63.1%	1.6%	10.9%	0.3%	773
Nariño	18.4%	64.2%	2.9%	12.7%	1.8%	4307
Neiva	19.5%	67.6%	2.0%	10.1%	0.7%	2436
Norte de Santander	21.3%	66.4%	2.6%	8.9%	0.7%	3655
Palmira	21.7%	64.4%	2.5%	10.2%	1.1%	1675
Pasto	19.5%	65.6%	2.5%	11.1%	1.2%	2702
Pereira	21.1%	66.2%	2.6%	8.7%	1.3%	2788
Piedecuesta	19.6%	69.5%	2.5%	7.6%	0.8%	855
Pitalito	22.4%	65.5%	1.8%	10.1%	0.3%	765
Popayán	21.3%	66.3%	2.0%	8.9%	1.5%	1835
Putumayo	19.8%	64.1%	3.3%	11.6%	1.2%	1990
Quibdó	24.7%	51.2%	4.4%	16.5%	3.2%	879
Quindío	22.2%	64.2%	3.0%	10.1%	0.6%	1688
Riohacha	22.3%	61.7%	3.6%	11.3%	1.0%	959
Rionegro	22.0%	67.8%	2.2%	7.0%	1.0%	830
Risaralda	21.8%	64.9%	3.1%	9.3%	0.9%	1502
Sabaneta	21.2%	71.1%	2.1%	5.0%	0.5%	377
Sahagún	22.3%	59.2%	4.9%	12.8%	0.9%	791
San Andrés	25.1%	58.8%	4.0%	9.9%	2.3%	354
Santa Marta	23.8%	60.2%	4.0%	10.7%	1.4%	2901
Santander	19.3%	69.8%	2.4%	7.9%	0.7%	4609

Continúa en la siguiente página



ETC/País	A	B	C	D	Omisión y multimarca	N° estudiantes
Sincelejo	21.3%	64.0%	4.0%	10.0%	0.7%	2119
Soacha	22.6%	64.7%	2.4%	9.4%	0.9%	3301
Sogamoso	18.9%	68.8%	2.0%	9.8%	0.6%	964
Soledad	23.7%	61.2%	3.8%	10.3%	1.0%	2582
Sucre	22.2%	58.9%	5.1%	13.1%	0.8%	3941
Tolima	23.7%	60.5%	3.6%	11.4%	0.8%	5128
Tuluá	22.4%	62.5%	4.3%	10.0%	0.8%	1315
Tumaco	21.4%	55.5%	4.4%	17.8%	0.9%	872
Tunja	19.5%	71.5%	2.2%	5.6%	1.3%	1177
Turbo	22.8%	55.7%	4.7%	14.3%	2.5%	804
Uribe	30.2%	55.7%	3.4%	8.7%	2.0%	149
Valle del Cauca	23.2%	61.0%	3.7%	10.4%	1.7%	4711
Valledupar	24.5%	59.0%	3.1%	11.9%	1.5%	2687
Vaupés	0.0%	50.0%	0.0%	0.0%	50.0%	4
Vichada	25.3%	55.5%	3.1%	15.3%	0.9%	229
Villavicencio	20.3%	66.5%	2.6%	9.8%	0.7%	3070
Yopal	21.6%	64.6%	1.8%	10.8%	1.1%	987
Yumbo	22.9%	64.7%	1.1%	9.9%	1.4%	737
Zipaquirá	22.2%	65.4%	1.5%	10.4%	0.5%	852
Colombia	21.7%	63.5%	3.1%	10.2%	1.4%	275339

*Es posible que los porcentajes mostrados no sumen exactamente 100 debido a aproximaciones decimales.

• Pregunta 25.

La tienda 2 pagó, en total, al distribuidor

- A. \$120.000
- B. \$147.000
- C. \$160.000
- D. \$167.000

• Estructura

Competencia	Planteamiento y resolución de problemas
Componente	Aleatorio
Afirmación	Resolver y formular problemas a partir de un conjunto de datos presentado en tablas, diagramas de barras y diagrama circular.
Nivel de desempeño	Satisfactorio
Respuesta Correcta	B

• Resultados a nivel nacional y de Entidad Territorial Certificada (ETC)

ETC/País	A	B	C	D	Omisión y multimarca	N° estudiantes
Amazonas	17.6%	38.8%	22.4%	18.8%	2.4%	410
Antioquia	14.5%	52.5%	18.0%	13.9%	1.2%	13194
Apartadó	14.1%	47.2%	23.2%	14.2%	1.2%	779
Arauca	12.7%	58.6%	15.7%	12.0%	1.0%	1239
Armenia	13.9%	55.1%	17.9%	12.1%	1.0%	1846
Atlántico	18.0%	42.5%	20.6%	17.7%	1.2%	3385
Barrancabermeja	13.3%	56.4%	17.2%	11.5%	1.7%	1305
Barranquilla	14.1%	55.3%	17.2%	12.0%	1.4%	6501
Bello	13.0%	55.2%	18.0%	13.0%	0.8%	2366
Bogotá, D.C.	10.6%	60.8%	15.3%	10.5%	2.9%	46573
Bolívar	19.4%	43.4%	20.4%	14.9%	1.9%	5373
Boyacá	11.5%	60.4%	16.9%	10.5%	0.8%	5615
Bucaramanga	8.7%	70.3%	12.0%	8.1%	0.8%	3743
Buenaventura	19.4%	41.8%	18.7%	16.9%	3.2%	1742
Buga	12.9%	52.6%	19.5%	12.0%	3.0%	635
Caldas	13.5%	55.1%	18.2%	12.4%	0.8%	3340
Cali	13.1%	55.7%	17.4%	11.5%	2.3%	12346
Caquetá	13.1%	59.5%	17.2%	9.7%	0.5%	1125
Cartagena	16.2%	49.0%	18.9%	14.0%	1.9%	6521
Cartago	12.3%	53.8%	20.6%	11.7%	1.6%	608
Casanare	11.7%	60.6%	15.6%	10.5%	1.5%	1435
Cauca	14.7%	51.3%	19.0%	13.2%	1.8%	5697
Cesar	16.9%	50.8%	17.2%	14.2%	1.0%	3688
Chocó	21.4%	36.0%	21.7%	19.2%	1.6%	1409
Chía	9.8%	64.7%	15.6%	8.8%	1.2%	971
Ciénaga	18.3%	45.2%	19.3%	16.3%	0.8%	747
Cundinamarca	11.4%	60.4%	16.2%	10.9%	1.0%	9587
Córdoba	19.7%	41.7%	20.9%	16.2%	1.4%	6076
Cúcuta	11.9%	61.6%	14.6%	10.9%	1.0%	4355
Dosquebradas	10.7%	56.9%	17.5%	13.5%	1.3%	931
Duitama	7.2%	74.0%	12.2%	6.2%	0.4%	951
Envigado	11.1%	61.3%	15.8%	10.6%	1.3%	1332
Facatativá	12.3%	61.6%	14.3%	10.6%	1.1%	790
Florencia	10.5%	60.1%	16.3%	12.5%	0.5%	933
Floridablanca	9.1%	69.1%	12.8%	7.9%	1.0%	1552
Fusagasugá	10.2%	63.2%	13.6%	12.6%	0.4%	854
Girardot	10.5%	56.4%	18.5%	13.0%	1.6%	731

Continúa en la siguiente página

GRADO 9° - MATEMÁTICAS

ETC/País	A	B	C	D	Omisión y multimarca	N° estudiantes
Girón	12.0%	62.5%	14.3%	10.1%	1.1%	715
Guainía	50.0%	50.0%	0.0%	0.0%	0.0%	2
Guaviare	14.3%	55.6%	17.4%	10.1%	2.6%	495
Huila	14.1%	54.7%	18.3%	12.1%	0.7%	4002
Ibagué	11.5%	58.3%	16.8%	12.2%	1.1%	3312
Ipiales	9.8%	64.2%	14.1%	10.8%	1.1%	723
Itagüí	14.7%	55.2%	15.1%	13.2%	1.7%	1269
Jamundí	15.4%	48.8%	21.3%	12.6%	1.9%	684
La Guajira	16.4%	45.6%	20.6%	15.1%	2.1%	1356
Lorica	21.4%	41.5%	19.4%	16.8%	1.0%	931
Magangué	19.9%	44.1%	18.5%	16.9%	0.5%	752
Magdalena	19.7%	41.7%	20.7%	16.6%	1.4%	3733
Maicao	17.1%	47.5%	18.6%	15.2%	1.6%	850
Malambo	17.5%	48.3%	16.6%	15.6%	2.0%	559
Manizales	12.2%	57.6%	17.5%	12.1%	0.6%	2372
Medellín	13.3%	54.4%	17.8%	13.1%	1.4%	13276
Meta	12.4%	57.3%	16.7%	12.3%	1.2%	2485
Montería	15.2%	52.4%	17.4%	13.1%	1.9%	2838
Mosquera	12.8%	57.8%	17.5%	11.5%	0.4%	773
Nariño	12.7%	57.3%	16.7%	11.0%	2.4%	4307
Neiva	11.3%	62.4%	15.1%	10.2%	0.9%	2436
Norte de Santander	12.1%	60.9%	14.7%	11.4%	0.8%	3655
Palmira	12.6%	59.4%	15.8%	11.3%	0.8%	1675
Pasto	11.0%	63.4%	14.8%	9.8%	1.0%	2702
Pereira	12.1%	58.2%	15.8%	12.8%	1.1%	2788
Piedecuesta	10.1%	66.0%	13.3%	9.9%	0.7%	855
Pitalito	11.5%	58.2%	16.9%	12.9%	0.5%	765
Popayán	9.6%	61.6%	15.2%	11.4%	2.2%	1835
Putumayo	11.3%	59.6%	15.9%	12.1%	1.1%	1990
Quibdó	21.3%	36.4%	23.7%	14.8%	3.9%	879
Quindío	14.2%	57.9%	17.2%	10.1%	0.6%	1688
Riohacha	19.2%	45.3%	18.4%	15.8%	1.4%	959
Rionegro	14.1%	59.3%	16.0%	9.9%	0.7%	830
Risaralda	14.4%	55.1%	16.6%	13.2%	0.7%	1502
Sabaneta	10.3%	64.7%	13.0%	11.1%	0.8%	377
Sahagún	18.5%	46.5%	19.6%	14.5%	0.9%	791
San Andrés	14.4%	48.9%	20.6%	14.1%	2.0%	354
Santa Marta	13.9%	53.9%	17.9%	12.8%	1.5%	2901
Santander	10.9%	64.2%	13.8%	10.4%	0.7%	4609

Continúa en la siguiente página



ETC/País	A	B	C	D	Omisión y multimarca	N° estudiantes
Sincelejo	16.7%	51.3%	18.8%	12.3%	1.0%	2119
Soacha	12.0%	60.1%	16.0%	11.2%	0.7%	3301
Sogamoso	9.3%	65.1%	15.2%	10.0%	0.3%	964
Soledad	15.6%	52.4%	18.2%	12.3%	1.5%	2582
Sucre	19.8%	42.3%	21.0%	15.9%	0.9%	3941
Tolima	15.0%	51.5%	18.4%	14.1%	0.9%	5128
Tuluá	16.7%	53.4%	16.3%	12.9%	0.8%	1315
Tumaco	19.4%	41.9%	21.3%	15.8%	1.6%	872
Tunja	9.8%	63.8%	15.4%	10.1%	0.9%	1177
Turbo	19.3%	39.1%	24.5%	14.8%	2.4%	804
Uribe	18.8%	40.9%	20.8%	18.8%	0.7%	149
Valle del Cauca	13.7%	51.3%	20.4%	12.9%	1.7%	4711
Valledupar	14.4%	50.5%	18.2%	15.2%	1.7%	2687
Vaupés	0.0%	25.0%	25.0%	0.0%	50.0%	4
Vichada	16.2%	51.5%	24.5%	6.6%	1.3%	229
Villavicencio	10.7%	63.5%	14.8%	10.3%	0.8%	3070
Yopal	10.2%	62.4%	16.3%	10.3%	0.7%	987
Yumbo	14.7%	52.4%	20.1%	11.8%	1.1%	737
Zipacquirá	7.7%	68.5%	14.7%	8.2%	0.8%	852
Colombia	13.4%	55.7%	17.1%	12.3%	1.6%	275339

*Es posible que los porcentajes mostrados no sumen exactamente 100 debido a aproximaciones decimales.

• **Pregunta 26.**

Observa las figuras dibujadas sobre la cuadrícula.

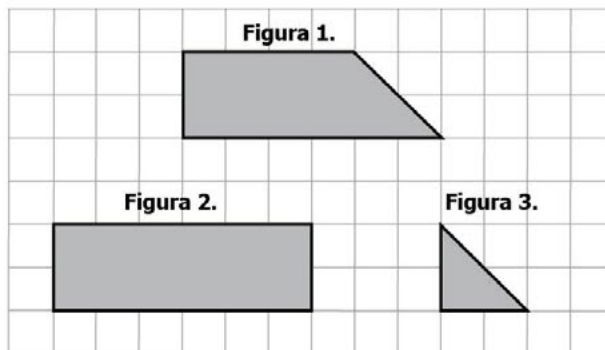

El área de la figura 2 es igual a

- A. el área de la figura 1 más el área de la figura 3.
- B. dos veces el área de la figura 1.
- C. tres veces el área de la figura 3.
- D. el área de la figura 1 menos el área de la figura 3.

• **Estructura**

Competencia	Razonamiento y argumentación
Componente	Geométrico - Métrico
Afirmación	Generalizar procedimientos de cálculo para encontrar el área de figuras planas y el volumen de algunos sólidos.
Nivel de desempeño	Satisfactorio
Respuesta Correcta	A

• Resultados a nivel nacional y de Entidad Territorial Certificada (ETC)

ETC/País	A	B	C	D	Omisión y multimarca	N° estudiantes
Amazonas	52.0%	16.1%	12.2%	18.5%	1.2%	410
Antioquia	60.6%	8.8%	13.7%	16.1%	0.7%	13194
Apartadó	57.9%	10.4%	15.9%	15.5%	0.3%	779
Arauca	65.2%	8.6%	13.2%	12.4%	0.6%	1239
Armenia	65.3%	7.7%	12.9%	13.5%	0.5%	1846
Atlántico	53.1%	12.9%	14.4%	19.0%	0.7%	3385
Barrancabermeja	63.5%	8.6%	12.3%	15.0%	0.6%	1305
Barranquilla	62.9%	8.7%	12.6%	15.0%	0.8%	6501
Bello	62.4%	8.3%	13.1%	15.7%	0.4%	2366
Bogotá, D.C.	69.3%	5.6%	10.3%	12.4%	2.4%	46573
Bolívar	52.0%	13.5%	15.7%	17.9%	0.9%	5373
Boyacá	67.2%	7.1%	12.9%	12.5%	0.3%	5615
Bucaramanga	74.8%	4.3%	8.9%	11.8%	0.2%	3743
Buenaventura	51.6%	12.6%	14.4%	19.2%	2.2%	1742
Buga	58.6%	8.0%	15.0%	15.9%	2.5%	635
Caldas	59.8%	8.8%	14.9%	15.9%	0.6%	3340
Cali	63.6%	7.9%	11.9%	15.2%	1.4%	12346
Caquetá	62.5%	9.0%	13.5%	14.4%	0.6%	1125
Cartagena	57.4%	10.5%	14.2%	17.1%	0.8%	6521
Cartago	67.1%	6.6%	10.9%	14.8%	0.7%	608
Casanare	63.5%	9.0%	12.1%	14.8%	0.6%	1435
Cauca	59.8%	9.4%	12.7%	17.4%	0.7%	5697
Cesar	55.6%	11.1%	14.5%	18.4%	0.3%	3688
Chocó	44.9%	14.5%	15.5%	24.3%	0.9%	1409
Chía	72.3%	3.9%	9.1%	14.5%	0.2%	971
Ciénaga	52.1%	13.3%	14.3%	20.1%	0.3%	747
Cundinamarca	67.1%	6.9%	12.4%	13.1%	0.5%	9587
Córdoba	50.3%	13.1%	16.8%	18.7%	1.1%	6076
Cúcuta	66.4%	8.1%	11.8%	13.4%	0.3%	4355
Dosquebradas	65.5%	5.8%	11.7%	16.4%	0.5%	931
Duitama	75.1%	5.4%	7.9%	11.1%	0.5%	951
Envigado	71.1%	5.1%	10.4%	13.1%	0.4%	1332
Facatativá	71.0%	6.3%	10.8%	11.8%	0.1%	790
Florencia	64.6%	7.3%	11.9%	15.5%	0.6%	933
Floridablanca	74.4%	4.6%	9.5%	11.0%	0.6%	1552
Fusagasugá	69.8%	5.4%	13.0%	11.4%	0.5%	854
Girardot	61.8%	10.0%	10.7%	16.7%	0.8%	731

Continúa en la siguiente página

GRADO 9° - MATEMÁTICAS

ETC/País	A	B	C	D	Omisión y multimarca	N° estudiantes
Girón	67.0%	7.7%	12.0%	12.6%	0.7%	715
Guainía	50.0%	0.0%	0.0%	50.0%	0.0%	2
Guaviare	59.6%	9.7%	13.9%	14.3%	2.4%	495
Huila	64.6%	8.8%	12.8%	13.6%	0.2%	4002
Ibagué	65.4%	7.2%	12.7%	14.2%	0.5%	3312
Ipiales	69.4%	5.4%	11.5%	13.1%	0.6%	723
Itagüí	60.3%	9.5%	14.2%	14.9%	1.1%	1269
Jamundí	56.9%	10.8%	13.9%	18.3%	0.1%	684
La Guajira	56.5%	10.3%	15.6%	16.2%	1.5%	1356
Lorica	50.7%	11.7%	19.0%	18.2%	0.4%	931
Magangué	57.6%	12.0%	11.4%	18.5%	0.5%	752
Magdalena	48.8%	14.0%	16.4%	20.2%	0.6%	3733
Maicao	49.3%	12.8%	17.2%	19.2%	1.5%	850
Malambo	57.1%	9.5%	15.6%	17.2%	0.7%	559
Manizales	65.5%	7.5%	13.2%	13.4%	0.5%	2372
Medellín	64.3%	7.7%	12.7%	14.5%	0.8%	13276
Meta	65.5%	8.0%	11.8%	13.9%	0.9%	2485
Montería	58.3%	10.2%	14.6%	15.8%	1.2%	2838
Mosquera	67.4%	6.9%	12.9%	12.4%	0.4%	773
Nariño	66.7%	6.8%	11.3%	13.5%	1.7%	4307
Neiva	65.5%	7.9%	11.5%	14.9%	0.2%	2436
Norte de Santander	64.2%	7.7%	13.9%	13.9%	0.4%	3655
Palmira	65.6%	6.9%	12.2%	14.6%	0.7%	1675
Pasto	70.8%	6.6%	10.3%	12.0%	0.3%	2702
Pereira	64.8%	6.3%	12.9%	15.0%	0.9%	2788
Piedecuesta	68.0%	6.5%	11.3%	13.7%	0.5%	855
Pitalito	68.5%	6.5%	12.9%	11.9%	0.1%	765
Popayán	69.3%	6.4%	10.0%	13.6%	0.8%	1835
Putumayo	66.5%	6.3%	12.3%	14.3%	0.7%	1990
Quibdó	50.5%	11.5%	15.8%	19.8%	2.4%	879
Quindío	64.1%	7.5%	12.9%	15.2%	0.2%	1688
Riohacha	53.5%	11.2%	17.0%	18.1%	0.2%	959
Rionegro	71.3%	5.3%	11.9%	10.8%	0.6%	830
Risaralda	60.5%	9.1%	13.4%	16.6%	0.5%	1502
Sabaneta	72.9%	3.7%	9.0%	13.5%	0.8%	377
Sahagún	53.9%	12.9%	15.7%	16.9%	0.6%	791
San Andrés	56.5%	10.7%	15.3%	15.8%	1.7%	354
Santa Marta	60.3%	9.3%	13.2%	16.3%	0.8%	2901
Santander	68.1%	7.2%	12.3%	12.0%	0.3%	4609

Continúa en la siguiente página



ETC/País	A	B	C	D	Omisión y multimarca	N° estudiantes
Sincelejo	61.8%	9.0%	13.0%	15.9%	0.3%	2119
Soacha	64.7%	8.2%	13.4%	13.2%	0.5%	3301
Sogamoso	68.7%	6.5%	11.7%	13.0%	0.1%	964
Soledad	59.3%	10.4%	14.4%	15.6%	0.3%	2582
Sucre	51.4%	13.3%	15.2%	19.5%	0.7%	3941
Tolima	57.9%	10.7%	15.0%	15.8%	0.5%	5128
Tuluá	60.0%	9.4%	12.5%	17.9%	0.2%	1315
Tumaco	55.4%	11.1%	16.1%	16.9%	0.6%	872
Tunja	71.5%	5.3%	10.3%	12.1%	0.8%	1177
Turbo	51.4%	12.2%	16.2%	18.9%	1.4%	804
Uribe	50.3%	22.8%	14.8%	12.1%	0.0%	149
Valle del Cauca	58.1%	9.9%	13.1%	18.0%	1.0%	4711
Valledupar	58.7%	9.7%	14.0%	16.3%	1.2%	2687
Vaupés	25.0%	25.0%	0.0%	0.0%	50.0%	4
Vichada	56.8%	10.9%	17.0%	14.4%	0.9%	229
Villavicencio	67.9%	7.4%	10.7%	13.7%	0.4%	3070
Yopal	69.5%	6.5%	11.6%	12.3%	0.2%	987
Yumbo	64.5%	9.0%	10.4%	15.9%	0.3%	737
Zipaquirá	70.1%	7.4%	11.3%	11.2%	0.1%	852
Colombia	63.2%	8.3%	12.7%	14.8%	1.0%	275339

*Es posible que los porcentajes mostrados no sumen exactamente 100 debido a aproximaciones decimales.

• **Pregunta 27.**

En cierta población el valor del consumo de agua de una vivienda se calcula de acuerdo con la siguiente información.

- Consumo mayor que 0 m³ y menor o igual que 20 m³ _____ Cada m³ o fracción vale \$600
- Consumo mayor que 20 m³ y menor o igual que 50 m³ _____ Cada m³ o fracción vale \$800
- Consumo mayor que 50 m³ _____ Cada m³ o fracción vale \$1.200

¿Cuál es la gráfica que relaciona el precio por m³ de agua con la cantidad de m³ de agua consumida en esa población?

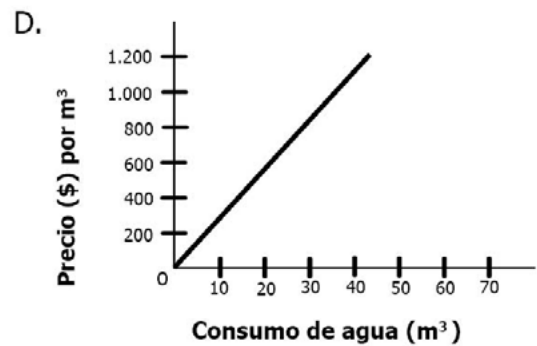
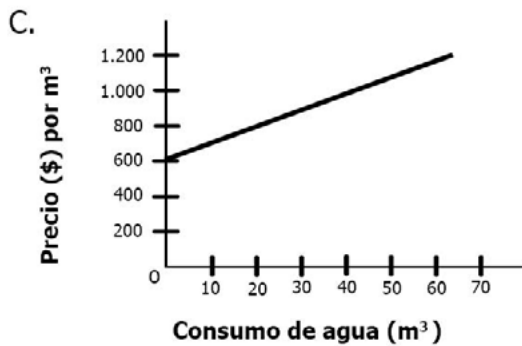
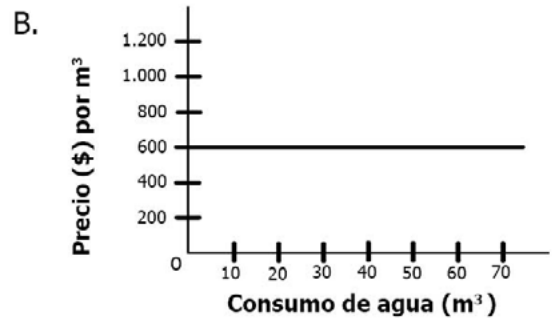
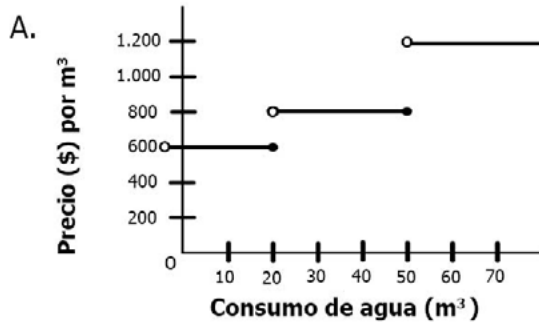

- **Estructura**

Competencia	Comunicación, representación y modelación
Componente	Numérico - variacional
Afirmación	Identificar características de gráficas cartesianas en relación con la situación que representan.
Nivel de desempeño	Satisfactorio
Respuesta Correcta	A

- **Resultados a nivel nacional y de Entidad Territorial Certificada (ETC)**

ETC/País	A	B	C	D	Omisión y multimarca	Nº estudiantes
Amazonas	42.2%	12.7%	19.0%	23.2%	2.9%	410
Antioquia	49.8%	12.4%	19.2%	17.4%	1.2%	13194
Apartadó	49.7%	15.7%	16.6%	16.6%	1.5%	779
Arauca	58.2%	7.6%	16.8%	16.7%	0.7%	1239
Armenia	56.2%	10.1%	18.1%	14.8%	0.8%	1846
Atlántico	51.4%	12.9%	17.0%	17.7%	1.0%	3385
Barrancabermeja	52.7%	9.6%	19.1%	17.8%	0.8%	1305
Barranquilla	55.8%	9.3%	16.4%	17.1%	1.4%	6501
Bello	49.6%	11.2%	19.7%	18.6%	1.0%	2366
Bogotá, D.C.	58.2%	6.3%	17.5%	15.3%	2.8%	46573
Bolívar	48.2%	14.3%	16.9%	19.1%	1.5%	5373
Boyacá	54.4%	8.4%	17.3%	19.1%	0.7%	5615
Bucaramanga	61.7%	6.0%	17.6%	14.2%	0.5%	3743
Buenaventura	50.6%	13.4%	14.2%	18.7%	3.0%	1742
Buga	52.3%	10.9%	20.8%	13.2%	2.8%	635
Caldas	52.5%	11.9%	17.5%	17.4%	0.7%	3340
Cali	55.5%	9.3%	16.9%	16.3%	2.0%	12346
Caquetá	49.7%	11.8%	18.8%	18.5%	1.2%	1125
Cartagena	54.2%	11.8%	15.9%	16.7%	1.4%	6521
Cartago	57.9%	8.6%	17.1%	15.1%	1.3%	608
Casanare	51.6%	9.5%	17.0%	20.9%	0.9%	1435
Cauca	51.9%	11.3%	16.9%	18.6%	1.3%	5697
Cesar	54.8%	11.6%	15.6%	17.1%	0.8%	3688
Chocó	41.8%	18.1%	18.3%	20.0%	1.8%	1409
Chía	60.4%	4.7%	18.3%	15.8%	0.8%	971

Continúa en la siguiente página

ETC/País	A	B	C	D	Omisión y multimarca	N° estudiantes
Ciénaga	48.3%	14.9%	19.7%	15.9%	1.2%	747
Cundinamarca	57.9%	7.9%	16.5%	16.8%	0.9%	9587
Córdoba	46.0%	15.6%	16.8%	20.3%	1.3%	6076
Cúcuta	59.4%	8.4%	15.9%	15.6%	0.8%	4355
Dosquebradas	57.3%	7.4%	18.2%	15.5%	1.7%	931
Duitama	64.4%	4.6%	16.5%	14.0%	0.5%	951
Envigado	57.5%	8.6%	16.7%	16.4%	0.8%	1332
Facatativá	58.0%	6.8%	17.8%	16.8%	0.5%	790
Florencia	55.3%	8.0%	17.9%	18.1%	0.6%	933
Floridablanca	59.5%	5.0%	18.4%	15.9%	1.2%	1552
Fusagasugá	56.8%	7.4%	17.2%	17.8%	0.8%	854
Girardot	55.3%	12.0%	17.4%	13.7%	1.6%	731
Girón	60.0%	6.6%	17.8%	14.8%	0.8%	715
Guainía	50.0%	0.0%	0.0%	50.0%	0.0%	2
Guaviare	45.9%	12.3%	18.2%	21.2%	2.4%	495
Huila	55.4%	9.4%	16.9%	17.7%	0.6%	4002
Ibagué	59.5%	8.0%	15.9%	15.4%	1.1%	3312
Ipiales	59.1%	7.1%	16.7%	16.0%	1.1%	723
Itagüí	48.2%	12.5%	19.7%	18.0%	1.6%	1269
Jamundí	49.9%	10.2%	19.2%	20.2%	0.6%	684
La Guajira	48.8%	14.9%	17.4%	16.8%	2.1%	1356
Lorica	41.9%	15.4%	20.2%	22.3%	0.2%	931
Magangué	50.9%	13.6%	17.3%	17.3%	0.9%	752
Magdalena	46.6%	15.1%	17.2%	19.9%	1.1%	3733
Maicao	44.0%	14.0%	17.6%	22.2%	2.1%	850
Malambo	53.1%	11.6%	15.2%	18.8%	1.3%	559
Manizales	53.1%	10.1%	19.9%	16.2%	0.7%	2372
Medellín	51.9%	10.3%	19.9%	16.5%	1.4%	13276
Meta	51.9%	11.1%	17.7%	18.0%	1.3%	2485
Montería	52.9%	10.0%	16.2%	19.3%	1.7%	2838
Mosquera	52.3%	7.1%	21.6%	17.9%	1.2%	773
Nariño	54.8%	8.5%	17.4%	17.2%	2.1%	4307
Neiva	61.1%	6.8%	16.5%	15.2%	0.4%	2436
Norte de Santander	54.5%	10.0%	17.3%	17.5%	0.6%	3655
Palmira	59.0%	8.5%	15.7%	15.8%	1.0%	1675
Pasto	59.7%	6.0%	16.8%	16.5%	1.0%	2702
Pereira	57.0%	7.9%	17.8%	16.1%	1.2%	2788
Piedecuesta	52.4%	8.5%	19.8%	18.0%	1.3%	855
Pitalito	58.0%	8.4%	16.7%	16.6%	0.3%	765

Continúa en la siguiente página



ETC/País	A	B	C	D	Omisión y multimarca	N° estudiantes
Popayán	59.5%	6.1%	15.4%	17.4%	1.6%	1835
Putumayo	56.1%	9.0%	16.2%	17.5%	1.2%	1990
Quibdó	40.4%	17.5%	18.4%	20.4%	3.3%	879
Quindío	51.2%	10.5%	20.4%	17.4%	0.5%	1688
Riohacha	46.2%	14.8%	19.5%	18.6%	0.9%	959
Rionegro	59.5%	9.2%	16.9%	14.3%	0.1%	830
Risaralda	54.3%	10.1%	17.2%	17.7%	0.7%	1502
Sabaneta	49.9%	10.6%	19.9%	18.6%	1.1%	377
Sahagún	48.3%	14.7%	18.7%	17.6%	0.8%	791
San Andrés	46.3%	12.7%	18.6%	20.9%	1.4%	354
Santa Marta	49.1%	12.7%	18.2%	18.0%	2.0%	2901
Santander	59.3%	7.6%	16.0%	16.6%	0.6%	4609
Sincelejo	55.2%	10.3%	16.8%	17.2%	0.6%	2119
Soacha	59.3%	8.7%	16.7%	14.5%	0.8%	3301
Sogamoso	61.6%	5.4%	15.4%	17.4%	0.2%	964
Soledad	55.5%	10.8%	16.4%	16.0%	1.3%	2582
Sucre	50.9%	13.8%	16.2%	18.1%	1.0%	3941
Tolima	53.5%	10.5%	16.2%	18.9%	0.9%	5128
Tuluá	51.7%	11.1%	20.5%	15.9%	0.8%	1315
Tumaco	52.2%	11.0%	16.9%	18.8%	1.1%	872
Tunja	61.8%	5.8%	16.0%	15.5%	1.0%	1177
Turbo	47.5%	17.5%	14.8%	18.2%	2.0%	804
Uribe	42.3%	15.4%	18.1%	22.8%	1.3%	149
Valle del Cauca	54.3%	10.5%	17.2%	16.6%	1.5%	4711
Valledupar	52.0%	10.7%	17.7%	17.9%	1.7%	2687
Vaupés	25.0%	25.0%	0.0%	0.0%	50.0%	4
Vichada	45.9%	15.3%	18.3%	20.1%	0.4%	229
Villavicencio	55.2%	8.4%	18.7%	17.0%	0.8%	3070
Yopal	61.2%	6.8%	16.3%	15.3%	0.4%	987
Yumbo	58.1%	11.0%	16.8%	13.2%	0.9%	737
Zipaquirá	58.8%	5.5%	17.7%	16.8%	1.2%	852
Colombia	54.6%	9.7%	17.4%	16.9%	1.5%	275339

*Es posible que los porcentajes mostrados no sumen exactamente 100 debido a aproximaciones decimales.

- **Pregunta 28.**

Don Rodrigo fue a la tienda a comprar ocho kilos y medio de arroz. Solamente encontró bolsas de 3 kilos, 1 kilo y $\frac{1}{2}$ kilo.

Él lleva exactamente la cantidad de arroz que necesita, si compra

- A. 2 bolsas de 3 kilos, 1 bolsa de 1 kilo y 1 bolsa de $\frac{1}{2}$ kilo.
- B. 1 bolsa de 3 kilos, 4 bolsas de 1 kilo y 5 bolsas de $\frac{1}{2}$ kilo.
- C. 2 bolsas de 3 kilos, 2 bolsas de 1 kilo y 1 bolsa de $\frac{1}{2}$ kilo.
- D. 1 bolsa de 3 kilos, 5 bolsas de 1 kilo y 3 bolsas de $\frac{1}{2}$ kilo.

- **Estructura**

Competencia	Planteamiento y resolución de problemas
Componente	Numérico - variacional
Afirmación	Resolver problemas en situaciones aditivas y multiplicativas en el conjunto de los números reales
Nivel de desempeño	Satisfactorio
Respuesta Correcta	C

• Resultados a nivel nacional y de Entidad Territorial Certificada (ETC)

ETC/País	A	B	C	D	Omisión y multimarca	N° estudiantes
Amazonas	30.2%	14.4%	40.5%	13.2%	1.7%	410
Antioquia	24.4%	13.0%	52.6%	8.9%	1.1%	13194
Apartadó	23.6%	18.0%	45.4%	11.9%	1.0%	779
Arauca	28.2%	11.1%	52.3%	7.7%	0.7%	1239
Armenia	20.8%	12.8%	57.3%	8.3%	0.8%	1846
Atlántico	28.1%	14.6%	46.0%	10.4%	1.0%	3385
Barrancabermeja	23.8%	13.5%	53.9%	8.1%	0.7%	1305
Barranquilla	22.2%	13.1%	55.8%	7.7%	1.2%	6501
Bello	21.6%	12.5%	55.8%	9.2%	0.9%	2366
Bogotá, D.C.	18.2%	10.8%	61.9%	6.4%	2.7%	46573
Bolívar	30.6%	15.9%	41.5%	10.6%	1.5%	5373
Boyacá	23.1%	13.6%	54.5%	8.3%	0.5%	5615
Bucaramanga	16.7%	9.3%	67.8%	5.7%	0.5%	3743
Buenaventura	26.6%	15.6%	43.6%	12.1%	2.1%	1742
Buga	20.0%	12.4%	56.5%	8.0%	3.0%	635
Caldas	24.0%	12.2%	54.3%	8.8%	0.7%	3340
Cali	21.3%	12.4%	55.8%	8.7%	1.8%	12346
Caquetá	24.4%	14.5%	51.4%	8.9%	0.8%	1125
Cartagena	25.2%	12.3%	51.6%	9.8%	1.1%	6521
Cartago	23.0%	12.5%	55.4%	8.1%	1.0%	608
Casanare	24.8%	12.9%	53.3%	8.1%	0.9%	1435
Cauca	28.3%	13.9%	46.4%	10.3%	1.1%	5697
Cesar	28.0%	14.8%	46.7%	9.8%	0.8%	3688
Chocó	32.4%	18.4%	34.6%	13.0%	1.6%	1409
Chía	17.0%	11.5%	65.6%	5.5%	0.4%	971
Ciénaga	27.8%	14.1%	45.8%	11.2%	1.1%	747
Cundinamarca	20.4%	12.8%	58.1%	8.1%	0.7%	9587
Córdoba	28.9%	15.5%	42.9%	11.4%	1.4%	6076
Cúcuta	24.6%	11.7%	56.5%	6.6%	0.6%	4355
Dosquebradas	21.6%	12.7%	57.1%	7.6%	1.0%	931
Duitama	15.2%	8.3%	70.7%	5.2%	0.6%	951
Envigado	17.6%	9.4%	68.0%	4.4%	0.6%	1332
Facatativá	19.1%	12.2%	60.6%	7.6%	0.5%	790
Florencia	23.8%	15.3%	53.3%	6.4%	1.2%	933
Floridablanca	18.5%	9.1%	65.6%	6.3%	0.6%	1552
Fusagasugá	22.4%	11.7%	58.9%	6.3%	0.7%	854
Girardot	23.9%	12.4%	52.0%	9.7%	1.9%	731

Continúa en la siguiente página

GRADO 9° - MATEMÁTICAS

ETC/País	A	B	C	D	Omisión y multimarca	N° estudiantes
Girón	21.3%	12.3%	56.6%	8.7%	1.1%	715
Guainía	0.0%	50.0%	0.0%	50.0%	0.0%	2
Guaviare	21.8%	17.8%	49.3%	9.1%	2.0%	495
Huila	24.7%	14.2%	51.4%	9.3%	0.4%	4002
Ibagué	20.3%	12.2%	59.4%	7.1%	1.1%	3312
Ipiales	22.1%	11.5%	59.1%	6.8%	0.6%	723
Itagüí	21.4%	14.3%	53.7%	8.8%	1.7%	1269
Jamundí	24.6%	13.7%	52.3%	8.2%	1.2%	684
La Guajira	29.1%	15.8%	44.8%	8.2%	2.1%	1356
Lorica	33.9%	16.0%	37.2%	12.0%	0.9%	931
Magangué	31.4%	12.6%	44.3%	10.5%	1.2%	752
Magdalena	29.8%	16.0%	41.6%	11.3%	1.3%	3733
Maicao	30.4%	16.0%	39.4%	12.5%	1.8%	850
Malambo	27.7%	11.8%	47.0%	12.5%	0.9%	559
Manizales	20.9%	11.5%	58.3%	8.7%	0.6%	2372
Medellín	20.9%	12.2%	57.2%	8.5%	1.2%	13276
Meta	22.1%	13.2%	54.4%	9.2%	1.2%	2485
Montería	28.2%	13.0%	49.0%	8.2%	1.7%	2838
Mosquera	22.0%	13.3%	57.3%	7.1%	0.3%	773
Nariño	25.4%	12.9%	51.6%	8.1%	2.0%	4307
Neiva	21.6%	12.6%	58.9%	6.6%	0.4%	2436
Norte de Santander	25.8%	11.1%	55.0%	7.5%	0.6%	3655
Palmira	19.5%	12.1%	59.9%	7.9%	0.7%	1675
Pasto	22.7%	11.1%	58.5%	7.0%	0.7%	2702
Pereira	21.2%	12.1%	58.1%	7.6%	1.0%	2788
Piedecuesta	23.4%	10.1%	59.3%	6.4%	0.8%	855
Pitalito	24.2%	12.2%	55.4%	7.8%	0.4%	765
Popayán	22.8%	11.6%	56.3%	7.9%	1.4%	1835
Putumayo	27.2%	12.5%	51.9%	7.2%	1.2%	1990
Quibdó	28.9%	16.5%	39.6%	11.7%	3.3%	879
Quindío	22.5%	14.3%	53.4%	8.8%	0.9%	1688
Riohacha	29.1%	13.9%	46.4%	10.0%	0.6%	959
Rionegro	21.4%	11.1%	59.0%	8.0%	0.5%	830
Risaralda	24.2%	11.5%	54.7%	8.3%	1.2%	1502
Sabaneta	18.0%	8.8%	64.2%	8.0%	1.1%	377
Sahagún	28.8%	15.4%	43.2%	11.5%	1.0%	791
San Andrés	24.6%	11.9%	48.0%	13.0%	2.5%	354
Santa Marta	24.9%	12.2%	51.9%	10.0%	1.0%	2901
Santander	22.7%	11.1%	58.6%	7.1%	0.5%	4609

Continúa en la siguiente página



ETC/País	A	B	C	D	Omisión y multimarca	N° estudiantes
Sincelejo	25.9%	13.2%	51.0%	9.2%	0.7%	2119
Soacha	21.7%	11.7%	57.5%	8.2%	0.9%	3301
Sogamoso	22.1%	11.4%	62.2%	4.0%	0.2%	964
Soledad	23.0%	13.8%	52.1%	10.1%	1.0%	2582
Sucre	32.1%	15.0%	40.8%	10.9%	1.1%	3941
Tolima	25.9%	14.5%	49.0%	9.7%	0.9%	5128
Tuluá	26.8%	14.1%	48.5%	9.7%	1.0%	1315
Tumaco	29.5%	14.8%	42.4%	12.0%	1.3%	872
Tunja	18.1%	9.8%	64.9%	6.0%	1.2%	1177
Turbo	29.7%	16.3%	39.9%	11.6%	2.5%	804
Uribe	31.5%	16.1%	39.6%	10.7%	2.0%	149
Valle del Cauca	24.1%	13.8%	51.6%	9.0%	1.4%	4711
Valledupar	28.5%	13.3%	48.1%	8.9%	1.3%	2687
Vaupés	0.0%	0.0%	50.0%	0.0%	50.0%	4
Vichada	31.4%	9.6%	49.8%	8.7%	0.4%	229
Villavicencio	21.7%	11.8%	58.3%	7.5%	0.7%	3070
Yopal	22.3%	11.9%	58.7%	6.8%	0.4%	987
Yumbo	24.8%	11.4%	54.0%	8.4%	1.4%	737
Zipacquirá	21.2%	9.7%	62.6%	5.9%	0.6%	852
Colombia	23.1%	12.6%	54.6%	8.3%	1.3%	275339

*Es posible que los porcentajes mostrados no sumen exactamente 100 debido a aproximaciones decimales.

• **Pregunta 29.**

En una tienda cada chocolatina tiene el mismo precio. La siguiente gráfica relaciona el número de chocolatinas y el precio correspondiente.

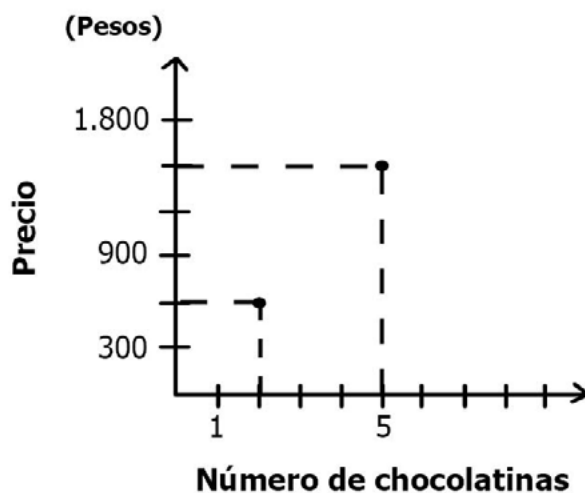

¿Cuál es el mayor número de chocolatinas que se puede comprar con 2.000 pesos?

- A. 4
- B. 5
- C. 6
- D. 7

• **Estructura**

Competencia	Planteamiento y resolución de problemas
Componente	Numérico - variacional
Afirmación	Resolver problemas en situaciones de variación con funciones polinómicas y exponenciales en contextos aritméticos y geométricos.
Nivel de desempeño	Satisfactorio
Respuesta Correcta	C

• Resultados a nivel nacional y de Entidad Territorial Certificada (ETC)

ETC/País	A	B	C	D	Omisión y multimarca	N° estudiantes
Amazonas	16.6%	24.9%	33.2%	24.4%	1.0%	410
Antioquia	10.3%	17.8%	46.4%	24.8%	0.7%	13194
Apartadó	14.6%	17.6%	43.1%	24.4%	0.3%	779
Arauca	8.7%	15.3%	48.2%	27.4%	0.4%	1239
Armenia	8.6%	15.8%	47.0%	28.3%	0.3%	1846
Atlántico	13.3%	23.9%	35.6%	26.9%	0.4%	3385
Barrancabermeja	8.2%	15.8%	45.4%	30.1%	0.5%	1305
Barranquilla	9.1%	17.1%	44.4%	28.5%	0.8%	6501
Bello	8.5%	18.0%	48.3%	24.9%	0.3%	2366
Bogotá, D.C.	6.2%	12.3%	50.1%	29.1%	2.4%	46573
Bolívar	14.6%	24.3%	35.2%	25.2%	0.8%	5373
Boyacá	7.1%	13.5%	52.7%	26.5%	0.3%	5615
Bucaramanga	5.0%	11.0%	56.2%	27.5%	0.2%	3743
Buenaventura	15.5%	25.9%	37.2%	19.6%	1.8%	1742
Buga	8.3%	17.6%	48.7%	22.7%	2.7%	635
Caldas	9.8%	17.3%	49.6%	22.9%	0.4%	3340
Cali	8.9%	16.1%	45.4%	28.3%	1.4%	12346
Caquetá	8.4%	17.2%	50.1%	23.9%	0.4%	1125
Cartagena	11.2%	19.0%	41.2%	27.7%	0.9%	6521
Cartago	8.1%	16.3%	47.0%	28.0%	0.7%	608
Casanare	8.2%	15.7%	50.1%	25.7%	0.3%	1435
Cauca	10.5%	20.4%	46.2%	22.2%	0.7%	5697
Cesar	10.2%	20.4%	43.0%	26.2%	0.2%	3688
Chocó	19.2%	28.2%	34.6%	17.2%	0.9%	1409
Chía	5.6%	11.3%	55.8%	27.0%	0.3%	971
Ciénaga	16.1%	21.0%	41.1%	21.6%	0.3%	747
Cundinamarca	7.4%	13.8%	51.7%	26.6%	0.5%	9587
Córdoba	15.1%	22.1%	35.4%	26.6%	0.9%	6076
Cúcuta	7.1%	16.1%	46.9%	29.4%	0.4%	4355
Dosquebradas	7.2%	14.6%	52.5%	25.1%	0.5%	931
Duitama	4.6%	9.0%	59.3%	26.9%	0.1%	951
Envigado	6.8%	12.8%	52.2%	27.7%	0.6%	1332
Facatativá	5.8%	13.2%	49.0%	32.0%	0.0%	790
Florencia	9.3%	16.7%	48.3%	25.2%	0.4%	933
Floridablanca	5.3%	12.1%	53.7%	28.2%	0.6%	1552
Fusagasugá	7.7%	13.5%	52.9%	25.8%	0.1%	854
Girardot	10.1%	18.1%	43.0%	27.5%	1.4%	731

Continúa en la siguiente página

GRADO 9° - MATEMÁTICAS

ETC/País	A	B	C	D	Omisión y multimarca	N° estudiantes
Girón	6.7%	13.3%	47.7%	31.7%	0.6%	715
Guainía	50.0%	0.0%	50.0%	0.0%	0.0%	2
Guaviare	11.5%	15.6%	46.9%	24.0%	2.0%	495
Huila	8.7%	16.1%	48.2%	26.8%	0.2%	4002
Ibagué	6.7%	15.6%	48.9%	28.1%	0.6%	3312
Ipiales	5.9%	12.4%	52.1%	28.9%	0.6%	723
Itagüí	9.5%	16.8%	44.9%	27.7%	1.1%	1269
Jamundí	12.7%	17.7%	42.0%	27.3%	0.3%	684
La Guajira	15.0%	20.6%	38.6%	24.3%	1.5%	1356
Lorica	16.6%	24.7%	34.6%	23.8%	0.2%	931
Magangué	11.8%	21.9%	39.0%	26.3%	0.9%	752
Magdalena	15.6%	25.2%	34.5%	24.0%	0.8%	3733
Maicao	13.5%	23.5%	36.0%	25.9%	1.1%	850
Malambo	14.1%	18.1%	41.7%	25.6%	0.5%	559
Manizales	8.6%	16.2%	47.2%	27.4%	0.5%	2372
Medellín	9.6%	16.2%	46.4%	27.0%	0.8%	13276
Meta	7.7%	16.9%	49.8%	24.8%	0.9%	2485
Montería	10.6%	18.3%	40.9%	28.9%	1.3%	2838
Mosquera	7.0%	14.6%	50.7%	27.6%	0.1%	773
Nariño	8.9%	14.8%	49.6%	25.1%	1.5%	4307
Neiva	7.4%	16.3%	48.2%	28.0%	0.1%	2436
Norte de Santander	8.0%	15.9%	46.8%	28.9%	0.5%	3655
Palmira	9.2%	16.4%	46.7%	27.2%	0.5%	1675
Pasto	7.3%	12.9%	47.6%	31.9%	0.3%	2702
Pereira	8.0%	15.4%	48.5%	27.4%	0.8%	2788
Piedecuesta	6.1%	14.0%	50.5%	28.9%	0.5%	855
Pitalito	9.5%	13.2%	49.0%	28.1%	0.1%	765
Popayán	5.9%	13.8%	51.4%	27.9%	1.0%	1835
Putumayo	7.5%	16.3%	49.7%	25.9%	0.5%	1990
Quibdó	13.9%	26.5%	36.3%	20.9%	2.4%	879
Quindío	10.3%	19.4%	45.6%	24.4%	0.2%	1688
Riohacha	11.4%	22.0%	40.7%	25.5%	0.4%	959
Rionegro	7.1%	14.8%	48.6%	29.2%	0.4%	830
Risaralda	9.8%	19.8%	47.9%	21.9%	0.6%	1502
Sabaneta	5.3%	13.5%	51.2%	29.4%	0.5%	377
Sahagún	14.3%	19.0%	39.6%	27.2%	0.0%	791
San Andrés	11.6%	22.6%	41.8%	22.0%	2.0%	354
Santa Marta	12.0%	19.0%	43.8%	24.3%	0.9%	2901
Santander	6.7%	12.9%	52.5%	27.6%	0.3%	4609

Continúa en la siguiente página



ETC/País	A	B	C	D	Omisión y multimarca	N° estudiantes
Sincelejo	10.5%	18.4%	43.0%	27.8%	0.2%	2119
Soacha	7.7%	15.8%	46.7%	29.4%	0.4%	3301
Sogamoso	6.0%	9.8%	54.3%	29.9%	0.1%	964
Soledad	10.0%	19.4%	42.6%	27.5%	0.5%	2582
Sucre	14.8%	23.2%	36.4%	25.1%	0.5%	3941
Tolima	9.9%	19.2%	45.3%	25.0%	0.5%	5128
Tuluá	8.5%	18.1%	45.1%	27.8%	0.5%	1315
Tumaco	17.1%	23.1%	40.4%	18.7%	0.8%	872
Tunja	6.0%	11.6%	54.0%	27.4%	0.9%	1177
Turbo	17.2%	23.9%	37.6%	19.4%	2.0%	804
Uribe	14.1%	27.5%	26.8%	31.5%	0.0%	149
Valle del Cauca	10.1%	19.5%	44.1%	25.5%	0.8%	4711
Valledupar	10.0%	19.5%	41.2%	28.2%	1.1%	2687
Vaupés	0.0%	25.0%	25.0%	0.0%	50.0%	4
Vichada	8.3%	24.0%	45.0%	22.7%	0.0%	229
Villavicencio	6.4%	14.6%	52.5%	26.2%	0.4%	3070
Yopal	5.8%	13.2%	55.4%	25.4%	0.2%	987
Yumbo	10.4%	17.0%	46.0%	26.2%	0.4%	737
Zipacquirá	4.5%	12.9%	55.5%	27.1%	0.0%	852
Colombia	9.1%	16.6%	46.5%	26.9%	1.0%	275339

*Es posible que los porcentajes mostrados no sumen exactamente 100 debido a aproximaciones decimales.

• **Pregunta 30.**

Un estudiante dejó caer una pelota 6 veces desde la azotea de un edificio de 20 m de altura. En la siguiente tabla, el estudiante registró el tiempo que tardó la pelota en llegar al suelo, en cada una de las caídas.

Número de caída	Tiempo de caída (segundos)
Primera	2
Segunda	2,1
Tercera	1,9
Cuarta	2
Quinta	1,8
Sexta	2,2

¿Cuál de los siguientes tiempos de caída fue menos probable, al observar los datos recolectados?

- A. 1,9 segundos.
- B. 2 segundos.
- C. 2,1 segundos.
- D. 3 segundos.

• **Estructura**

Competencia	Planteamiento y resolución de problemas
Componente	Aleatorio
Afirmación	Resolver problemas que requieran el uso e interpretación de medidas de tendencia central para analizar el comportamiento de un conjunto de datos.
Nivel de desempeño	Satisfactorio
Respuesta Correcta	D

• Resultados a nivel nacional y de Entidad Territorial Certificada (ETC)

ETC/País	A	B	C	D	Omisión y multimarca	N° estudiantes
Amazonas	19.5%	21.0%	13.9%	43.9%	1.7%	410
Antioquia	15.4%	15.5%	10.2%	58.1%	0.7%	13194
Apartadó	18.7%	19.9%	13.5%	47.6%	0.3%	779
Arauca	16.0%	16.8%	10.9%	55.8%	0.6%	1239
Armenia	16.3%	16.4%	9.3%	57.6%	0.4%	1846
Atlántico	17.6%	17.2%	13.2%	51.3%	0.6%	3385
Barrancabermeja	16.2%	17.9%	11.0%	54.4%	0.5%	1305
Barranquilla	15.3%	16.9%	11.1%	55.7%	1.0%	6501
Bello	15.0%	17.4%	9.3%	57.8%	0.5%	2366
Bogotá, D.C.	12.0%	16.6%	8.2%	60.9%	2.4%	46573
Bolívar	19.8%	18.3%	14.8%	46.3%	0.8%	5373
Boyacá	14.6%	17.7%	9.7%	57.5%	0.4%	5615
Bucaramanga	11.9%	15.4%	7.9%	64.5%	0.3%	3743
Buenaventura	18.0%	17.7%	12.9%	49.4%	2.0%	1742
Buga	14.5%	15.1%	9.9%	58.0%	2.5%	635
Caldas	15.3%	15.4%	8.7%	60.1%	0.5%	3340
Cali	14.8%	16.5%	10.2%	57.0%	1.5%	12346
Caquetá	16.7%	15.6%	11.1%	56.0%	0.5%	1125
Cartagena	16.8%	19.1%	13.3%	50.0%	0.8%	6521
Cartago	13.7%	14.0%	8.7%	62.8%	0.8%	608
Casanare	15.5%	15.7%	9.4%	58.5%	0.8%	1435
Cauca	16.3%	17.0%	11.0%	55.0%	0.8%	5697
Cesar	16.0%	18.0%	12.6%	52.9%	0.5%	3688
Chocó	20.9%	16.5%	14.4%	47.1%	1.0%	1409
Chía	9.3%	14.8%	8.8%	67.0%	0.1%	971
Ciénaga	14.2%	16.9%	18.5%	49.8%	0.7%	747
Cundinamarca	13.5%	16.3%	9.1%	60.4%	0.7%	9587
Córdoba	18.0%	16.7%	14.3%	49.9%	1.0%	6076
Cúcuta	14.6%	16.9%	10.1%	57.9%	0.6%	4355
Dosquebradas	14.0%	14.8%	6.4%	64.0%	0.8%	931
Duitama	10.9%	17.8%	6.7%	63.9%	0.6%	951
Envigado	11.6%	14.3%	8.1%	65.3%	0.7%	1332
Facatativá	13.2%	18.9%	10.5%	57.3%	0.1%	790
Florencia	15.3%	16.7%	10.7%	56.6%	0.6%	933
Floridablanca	14.7%	16.8%	7.6%	60.2%	0.7%	1552
Fusagasugá	13.9%	17.3%	10.1%	58.3%	0.4%	854
Girardot	15.6%	17.8%	12.6%	53.2%	0.8%	731

Continúa en la siguiente página

GRADO 9° - MATEMÁTICAS

ETC/País	A	B	C	D	Omisión y multimarca	N° estudiantes
Girón	13.6%	17.2%	9.5%	59.2%	0.6%	715
Guainía	50.0%	0.0%	0.0%	50.0%	0.0%	2
Guaviare	15.4%	15.4%	10.7%	56.6%	2.0%	495
Huila	15.7%	17.9%	10.9%	55.2%	0.3%	4002
Ibagué	14.6%	18.0%	9.5%	57.2%	0.7%	3312
Ipiales	12.2%	18.8%	9.7%	58.8%	0.6%	723
Itagüí	15.1%	16.7%	10.4%	56.7%	1.0%	1269
Jamundí	15.1%	17.8%	13.0%	53.9%	0.1%	684
La Guajira	14.9%	19.1%	11.7%	52.6%	1.7%	1356
Lorica	20.0%	17.4%	15.9%	46.1%	0.6%	931
Magangué	15.2%	17.2%	12.5%	54.4%	0.8%	752
Magdalena	20.2%	17.5%	15.5%	46.0%	0.8%	3733
Maicao	16.9%	21.1%	13.8%	46.5%	1.8%	850
Malambo	18.1%	17.4%	14.1%	50.1%	0.4%	559
Manizales	14.0%	17.4%	9.2%	58.9%	0.5%	2372
Medellín	14.6%	16.5%	9.9%	58.2%	0.9%	13276
Meta	15.7%	18.2%	10.1%	55.1%	0.8%	2485
Montería	18.3%	16.3%	11.8%	52.2%	1.3%	2838
Mosquera	14.0%	16.2%	9.8%	59.9%	0.1%	773
Nariño	14.1%	15.9%	9.1%	58.9%	2.0%	4307
Neiva	14.7%	19.4%	9.3%	56.3%	0.3%	2436
Norte de Santander	15.7%	17.7%	9.4%	56.6%	0.6%	3655
Palmira	15.2%	16.7%	8.5%	58.9%	0.8%	1675
Pasto	14.2%	15.8%	7.8%	61.7%	0.4%	2702
Pereira	13.0%	16.4%	8.4%	61.5%	0.7%	2788
Piedecuesta	13.5%	18.4%	8.7%	58.8%	0.7%	855
Pitalito	13.9%	20.0%	10.3%	55.8%	0.0%	765
Popayán	15.0%	15.6%	8.3%	59.8%	1.1%	1835
Putumayo	16.1%	18.3%	11.3%	53.6%	0.7%	1990
Quibdó	17.9%	18.5%	13.5%	47.0%	3.1%	879
Quindío	15.2%	15.8%	11.1%	57.5%	0.3%	1688
Riohacha	17.3%	17.1%	12.4%	52.7%	0.5%	959
Rionegro	13.1%	15.4%	6.9%	63.6%	1.0%	830
Risaralda	15.0%	15.0%	9.7%	59.7%	0.6%	1502
Sabaneta	13.0%	10.9%	8.0%	67.4%	0.8%	377
Sahagún	19.3%	16.6%	13.4%	50.4%	0.3%	791
San Andrés	15.0%	19.2%	15.0%	48.6%	2.3%	354
Santa Marta	17.0%	17.7%	11.8%	52.5%	1.0%	2901
Santander	14.0%	15.6%	8.7%	61.4%	0.3%	4609

Continúa en la siguiente página



ETC/País	A	B	C	D	Omisión y multimarca	N° estudiantes
Sincelejo	17.4%	18.8%	11.2%	52.0%	0.6%	2119
Soacha	14.8%	17.8%	9.8%	57.1%	0.4%	3301
Sogamoso	14.1%	18.3%	8.4%	58.9%	0.3%	964
Soledad	15.5%	18.5%	12.7%	52.6%	0.7%	2582
Sucre	18.5%	18.3%	13.5%	49.0%	0.7%	3941
Tolima	15.4%	16.9%	11.3%	55.7%	0.6%	5128
Tuluá	15.4%	15.5%	10.0%	58.7%	0.4%	1315
Tumaco	16.2%	16.4%	12.7%	53.8%	0.9%	872
Tunja	12.1%	15.3%	8.6%	63.1%	0.9%	1177
Turbo	17.2%	17.9%	15.2%	48.3%	1.5%	804
Uribe	18.8%	20.8%	15.4%	45.0%	0.0%	149
Valle del Cauca	15.7%	15.7%	10.8%	56.7%	1.1%	4711
Valledupar	16.2%	19.1%	11.8%	51.8%	1.2%	2687
Vaupés	25.0%	0.0%	0.0%	25.0%	50.0%	4
Vichada	14.4%	14.8%	13.5%	57.2%	0.0%	229
Villavicencio	16.1%	17.3%	8.7%	57.4%	0.5%	3070
Yopal	13.8%	18.8%	10.4%	56.7%	0.2%	987
Yumbo	16.1%	17.5%	11.5%	54.4%	0.4%	737
Zipaquirá	12.4%	17.8%	8.8%	60.7%	0.2%	852
Colombia	14.9%	16.9%	10.3%	56.8%	1.1%	275339

*Es posible que los porcentajes mostrados no sumen exactamente 100 debido a aproximaciones decimales.

• **Pregunta 31.**

Observa la siguiente pirámide.

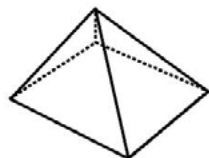

¿Con cuáles de los siguientes desarrollos planos se puede formar la pirámide?

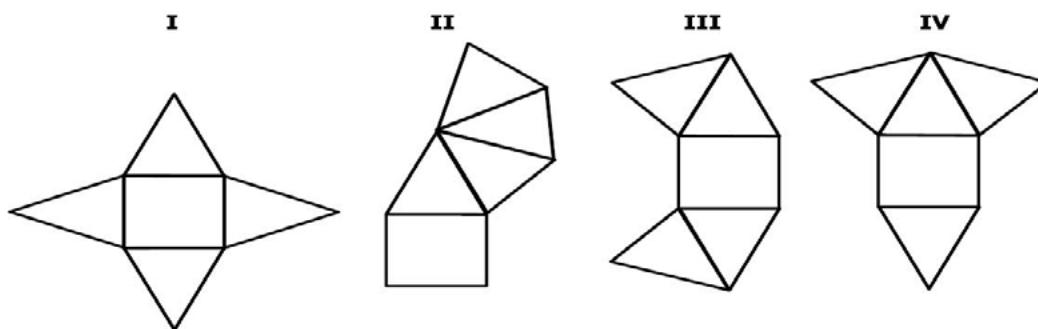

- A. Con I y con III solamente.
- B. Con I, II y IV solamente.
- C. Con II y con IV solamente.
- D. Con II, con III y con IV solamente.

• **Estructura**

Competencia	Razonamiento y argumentación
Componente	Geométrico - métrico
Afirmación	Argumentar formal e informalmente sobre propiedades y relaciones de figuras planas y sólidos.
Nivel de desempeño	Satisfactorio
Respuesta Correcta	B

• Resultados a nivel nacional y de Entidad Territorial Certificada (ETC)

ETC/País	A	B	C	D	Omisión y multimarca	N° estudiantes
Amazonas	27.6%	39.8%	18.5%	11.7%	2.4%	410
Antioquia	27.1%	44.1%	18.1%	9.9%	0.9%	13194
Apartadó	27.5%	39.0%	23.4%	9.5%	0.6%	779
Arauca	26.6%	48.4%	16.1%	8.3%	0.6%	1239
Armenia	20.3%	53.0%	18.7%	7.5%	0.5%	1846
Atlántico	33.5%	40.9%	16.0%	9.0%	0.7%	3385
Barrancabermeja	21.5%	52.9%	16.6%	8.0%	1.0%	1305
Barranquilla	27.8%	48.3%	15.4%	7.4%	1.1%	6501
Bello	24.0%	52.7%	15.2%	7.4%	0.6%	2366
Bogotá, D.C.	17.6%	59.5%	14.3%	6.2%	2.4%	46573
Bolívar	32.1%	36.3%	18.2%	12.3%	1.1%	5373
Boyacá	24.5%	47.6%	18.3%	9.1%	0.5%	5615
Bucaramanga	16.8%	61.3%	14.5%	6.8%	0.5%	3743
Buenaventura	31.5%	36.2%	18.7%	11.1%	2.5%	1742
Buga	25.4%	45.8%	17.3%	9.0%	2.5%	635
Caldas	28.3%	43.6%	18.3%	9.4%	0.5%	3340
Cali	22.8%	52.3%	15.9%	7.5%	1.6%	12346
Caquetá	29.2%	44.2%	16.5%	9.2%	0.9%	1125
Cartagena	27.9%	45.8%	16.4%	9.0%	0.9%	6521
Cartago	22.5%	50.3%	17.4%	8.6%	1.2%	608
Casanare	23.8%	47.5%	18.6%	9.3%	0.8%	1435
Cauca	30.4%	39.9%	18.2%	10.5%	1.0%	5697
Cesar	30.7%	41.2%	17.3%	10.2%	0.5%	3688
Chocó	36.4%	25.6%	21.5%	14.9%	1.6%	1409
Chía	16.4%	62.4%	15.2%	5.7%	0.3%	971
Ciénaga	31.7%	39.2%	17.9%	10.7%	0.4%	747
Cundinamarca	21.7%	53.1%	16.6%	8.0%	0.6%	9587
Córdoba	33.3%	35.4%	18.3%	11.8%	1.2%	6076
Cúcuta	24.4%	53.3%	14.9%	6.8%	0.6%	4355
Dosquebradas	19.3%	55.2%	16.9%	7.6%	1.0%	931
Duitama	16.0%	65.4%	12.9%	5.4%	0.3%	951
Envigado	17.3%	59.2%	15.0%	7.7%	0.8%	1332
Facatativá	22.3%	56.6%	15.3%	5.7%	0.1%	790
Florencia	26.4%	52.9%	13.2%	6.9%	0.6%	933
Floridablanca	20.2%	58.8%	13.6%	6.7%	0.7%	1552
Fusagasugá	18.4%	57.3%	16.6%	7.4%	0.4%	854
Girardot	26.4%	47.2%	17.0%	8.6%	0.8%	731

Continúa en la siguiente página

GRADO 9° - MATEMÁTICAS

ETC/País	A	B	C	D	Omisión y multimarca	N° estudiantes
Girón	23.4%	51.7%	16.5%	7.8%	0.6%	715
Guainía	50.0%	0.0%	50.0%	0.0%	0.0%	2
Guaviare	26.9%	43.0%	17.8%	9.5%	2.8%	495
Huila	24.3%	50.7%	16.2%	8.4%	0.4%	4002
Ibagué	23.0%	51.5%	17.1%	7.7%	0.7%	3312
Ipiales	17.0%	62.7%	15.2%	4.7%	0.4%	723
Itagüí	21.7%	51.1%	17.8%	8.4%	0.9%	1269
Jamundí	27.5%	43.3%	18.6%	10.1%	0.6%	684
La Guajira	31.4%	42.0%	16.7%	8.1%	1.8%	1356
Lorica	33.8%	33.0%	18.9%	13.6%	0.6%	931
Magangué	32.2%	37.2%	18.8%	10.8%	1.1%	752
Magdalena	34.8%	32.1%	19.0%	12.9%	1.1%	3733
Maicao	31.9%	36.7%	17.6%	11.8%	2.0%	850
Malambo	32.0%	44.9%	14.0%	8.2%	0.9%	559
Manizales	23.9%	50.5%	17.0%	8.1%	0.5%	2372
Medellín	22.7%	51.6%	16.5%	8.2%	1.0%	13276
Meta	24.2%	51.6%	16.3%	7.1%	0.8%	2485
Montería	28.9%	47.7%	14.2%	7.8%	1.4%	2838
Mosquera	18.6%	58.0%	15.5%	7.6%	0.3%	773
Nariño	22.5%	49.8%	16.1%	9.8%	1.9%	4307
Neiva	20.2%	55.4%	16.3%	7.8%	0.3%	2436
Norte de Santander	25.5%	46.7%	17.8%	9.3%	0.6%	3655
Palmira	20.5%	56.4%	15.3%	6.8%	1.0%	1675
Pasto	16.6%	61.2%	14.7%	7.0%	0.4%	2702
Pereira	21.1%	53.9%	17.1%	6.9%	0.9%	2788
Piedecuesta	21.9%	51.0%	20.1%	6.4%	0.6%	855
Pitalito	20.0%	53.3%	20.4%	6.1%	0.1%	765
Popayán	20.8%	56.3%	15.2%	6.8%	0.9%	1835
Putumayo	23.3%	51.9%	15.5%	8.5%	0.8%	1990
Quibdó	37.9%	32.4%	15.5%	11.4%	2.8%	879
Quindío	25.6%	45.9%	18.8%	9.3%	0.5%	1688
Riohacha	31.1%	43.1%	16.8%	8.6%	0.5%	959
Rionegro	19.2%	51.7%	17.1%	11.2%	0.8%	830
Risaralda	27.5%	47.5%	16.5%	7.9%	0.6%	1502
Sabaneta	18.0%	61.3%	13.5%	6.6%	0.5%	377
Sahagún	31.6%	38.9%	18.1%	11.3%	0.1%	791
San Andrés	24.3%	45.5%	17.8%	10.7%	1.7%	354
Santa Marta	30.6%	43.7%	16.3%	8.3%	1.1%	2901
Santander	23.3%	49.2%	17.5%	9.5%	0.4%	4609

Continúa en la siguiente página



ETC/País	A	B	C	D	Omisión y multimarca	N° estudiantes
Sincelejo	26.8%	48.1%	16.6%	8.1%	0.5%	2119
Soacha	21.5%	55.5%	15.6%	7.0%	0.5%	3301
Sogamoso	21.2%	58.4%	13.9%	6.5%	0.0%	964
Soledad	29.3%	47.4%	14.6%	7.9%	0.8%	2582
Sucre	30.1%	38.6%	18.9%	11.5%	0.9%	3941
Tolima	29.1%	44.1%	16.9%	9.2%	0.6%	5128
Tuluá	27.2%	44.9%	19.5%	7.3%	1.1%	1315
Tumaco	31.4%	35.4%	19.6%	12.4%	1.1%	872
Tunja	15.5%	60.1%	15.0%	8.6%	0.8%	1177
Turbo	36.3%	29.5%	19.4%	12.2%	2.6%	804
Uribe	35.6%	32.2%	22.8%	8.7%	0.7%	149
Valle del Cauca	26.8%	45.3%	17.5%	9.3%	1.1%	4711
Valledupar	30.5%	44.0%	14.4%	9.9%	1.3%	2687
Vaupés	0.0%	50.0%	0.0%	0.0%	50.0%	4
Vichada	33.6%	35.4%	17.9%	10.9%	2.2%	229
Villavicencio	20.4%	54.4%	17.6%	7.1%	0.6%	3070
Yopal	21.0%	53.4%	17.1%	8.3%	0.2%	987
Yumbo	22.7%	52.4%	16.7%	7.6%	0.7%	737
Zipacquirá	15.8%	62.2%	15.1%	6.5%	0.4%	852
Colombia	24.3%	49.8%	16.4%	8.4%	1.1%	275339

*Es posible que los porcentajes mostrados no sumen exactamente 100 debido a aproximaciones decimales.

• Pregunta 32.

Cuando en un grupo cada persona abraza a otra del grupo una sola vez, el número total de abrazos, a , se calcula mediante la expresión, $a = \frac{n(n-1)}{2}$ donde n es el número de personas en el grupo.

¿Cuál es el valor de a para un grupo de 5 personas?

- A. 3
- B. 5
- C. 10
- D. 15

• Estructura

Competencia	Comunicación, representación y modelación
Componente	Numérico - variacional
Afirmación	Identificar expresiones numéricas y algebraicas equivalentes.
Nivel de desempeño	Satisfactorio
Respuesta Correcta	C

• Resultados a nivel nacional y de Entidad Territorial Certificada (ETC)

ETC/País	A	B	C	D	Omisión y multimarca	N° estudiantes
Amazonas	21.2%	23.4%	41.5%	11.2%	2.7%	410
Antioquia	18.6%	27.1%	43.2%	9.7%	1.5%	13194
Apartadó	22.1%	23.7%	39.0%	13.9%	1.3%	779
Arauca	14.8%	24.9%	49.2%	10.0%	1.0%	1239
Armenia	16.0%	25.8%	47.1%	9.7%	1.4%	1846
Atlántico	21.1%	25.7%	42.1%	9.8%	1.3%	3385
Barrancabermeja	18.6%	25.1%	46.1%	8.9%	1.3%	1305
Barranquilla	18.4%	21.9%	49.6%	8.2%	1.9%	6501
Bello	15.9%	24.6%	48.0%	10.0%	1.5%	2366
Bogotá, D.C.	14.3%	23.0%	52.9%	6.7%	3.0%	46573
Bolívar	23.5%	24.3%	39.0%	11.4%	1.8%	5373
Boyacá	16.4%	27.1%	47.8%	7.9%	0.8%	5615
Bucaramanga	14.9%	20.4%	57.3%	6.4%	1.0%	3743
Buenaventura	21.6%	23.8%	41.4%	10.2%	3.1%	1742
Buga	18.7%	23.6%	48.0%	6.6%	3.0%	635
Caldas	17.8%	29.8%	42.5%	8.8%	1.0%	3340
Cali	17.3%	24.4%	47.4%	8.2%	2.7%	12346
Caquetá	15.2%	28.2%	46.5%	8.9%	1.2%	1125
Cartagena	19.8%	23.0%	45.5%	9.7%	2.0%	6521
Cartago	16.8%	29.6%	44.7%	7.4%	1.5%	608
Casanare	16.9%	25.0%	47.1%	9.4%	1.5%	1435
Cauca	17.9%	26.7%	44.6%	8.9%	1.9%	5697
Cesar	20.4%	26.1%	43.7%	8.8%	1.0%	3688
Chocó	22.1%	27.3%	36.6%	12.0%	1.9%	1409
Chía	11.5%	22.7%	58.8%	6.6%	0.4%	971
Ciénaga	18.3%	25.0%	43.4%	11.1%	2.1%	747
Cundinamarca	16.4%	25.8%	49.5%	7.2%	1.2%	9587
Córdoba	21.1%	26.3%	40.0%	10.9%	1.7%	6076
Cúcuta	15.5%	23.7%	52.3%	7.5%	1.1%	4355
Dosquebradas	17.5%	22.9%	50.8%	7.6%	1.2%	931
Duitama	10.1%	20.4%	64.8%	4.3%	0.4%	951
Envigado	12.1%	17.1%	63.4%	6.5%	0.9%	1332
Facatativá	15.9%	25.2%	50.3%	8.0%	0.6%	790
Florencia	16.0%	28.6%	47.1%	7.0%	1.4%	933
Floridablanca	14.1%	20.4%	56.6%	7.6%	1.3%	1552
Fusagasugá	15.9%	27.8%	46.6%	7.6%	2.1%	854
Girardot	18.9%	28.3%	41.3%	9.4%	2.1%	731

Continúa en la siguiente página

GRADO 9° - MATEMÁTICAS

ETC/País	A	B	C	D	Omisión y multimarca	N° estudiantes
Girón	17.8%	25.2%	47.4%	8.4%	1.3%	715
Guainía	50.0%	0.0%	50.0%	0.0%	0.0%	2
Guaviare	16.8%	28.9%	44.6%	7.3%	2.4%	495
Huila	18.3%	26.5%	46.4%	8.2%	0.7%	4002
Ibagué	17.0%	26.5%	47.0%	7.9%	1.5%	3312
Ipiales	12.9%	26.3%	53.3%	6.5%	1.1%	723
Itagüí	18.4%	22.8%	44.9%	11.9%	2.0%	1269
Jamundí	25.9%	25.9%	38.7%	8.5%	1.0%	684
La Guajira	20.4%	24.4%	42.6%	10.5%	2.1%	1356
Lorica	23.3%	27.9%	36.0%	11.8%	1.0%	931
Magangué	23.1%	25.9%	40.4%	9.7%	0.8%	752
Magdalena	23.8%	26.1%	38.3%	10.3%	1.5%	3733
Maicao	21.3%	26.9%	41.1%	8.4%	2.4%	850
Malambo	22.5%	22.7%	44.5%	8.6%	1.6%	559
Manizales	18.2%	23.3%	48.4%	9.2%	0.9%	2372
Medellín	16.6%	24.6%	47.9%	9.4%	1.6%	13276
Meta	16.6%	28.0%	44.9%	9.0%	1.5%	2485
Montería	18.7%	24.3%	46.7%	7.9%	2.4%	2838
Mosquera	15.3%	26.6%	50.2%	7.2%	0.6%	773
Nariño	15.1%	24.4%	50.4%	7.8%	2.4%	4307
Neiva	17.2%	24.1%	50.4%	7.4%	0.9%	2436
Norte de Santander	16.9%	26.5%	46.7%	8.5%	1.3%	3655
Palmira	14.9%	23.7%	53.1%	7.0%	1.3%	1675
Pasto	13.0%	20.1%	57.9%	8.0%	1.0%	2702
Pereira	15.5%	24.0%	50.6%	8.4%	1.4%	2788
Piedecuesta	17.2%	22.6%	52.2%	6.8%	1.3%	855
Pitalito	17.8%	25.6%	50.3%	5.5%	0.8%	765
Popayán	13.0%	22.7%	55.6%	6.9%	1.8%	1835
Putumayo	17.3%	25.2%	47.6%	8.7%	1.2%	1990
Quibdó	18.9%	29.0%	37.8%	10.5%	3.9%	879
Quindío	20.3%	26.4%	43.4%	9.1%	0.8%	1688
Riohacha	19.1%	24.4%	44.7%	10.4%	1.4%	959
Rionegro	15.9%	24.7%	49.4%	8.3%	1.7%	830
Risaralda	20.1%	27.9%	41.9%	9.1%	1.0%	1502
Sabaneta	12.2%	18.6%	60.7%	6.6%	1.9%	377
Sahagún	21.9%	28.6%	38.4%	10.0%	1.1%	791
San Andrés	20.9%	19.5%	47.2%	10.2%	2.3%	354
Santa Marta	20.0%	27.5%	43.0%	7.8%	1.8%	2901
Santander	16.2%	25.3%	50.9%	6.9%	0.7%	4609

Continúa en la siguiente página



ETC/País	A	B	C	D	Omisión y multimarca	N° estudiantes
Sincelejo	18.7%	23.7%	49.2%	7.4%	0.9%	2119
Soacha	18.1%	27.1%	46.0%	7.8%	1.2%	3301
Sogamoso	10.9%	25.2%	57.0%	6.5%	0.4%	964
Soledad	19.8%	23.1%	46.2%	9.3%	1.6%	2582
Sucre	21.5%	23.8%	43.9%	9.4%	1.4%	3941
Tolima	20.2%	27.9%	42.9%	8.0%	1.1%	5128
Tuluá	17.4%	28.3%	43.3%	9.2%	1.8%	1315
Tumaco	22.2%	25.7%	40.7%	9.4%	1.9%	872
Tunja	12.1%	25.2%	55.3%	6.0%	1.3%	1177
Turbo	24.0%	27.2%	35.1%	10.8%	2.9%	804
Uribe	26.8%	22.1%	38.3%	12.1%	0.7%	149
Valle del Cauca	19.9%	26.6%	43.1%	8.6%	1.8%	4711
Valledupar	20.2%	26.1%	42.5%	9.2%	2.0%	2687
Vaupés	0.0%	0.0%	25.0%	25.0%	50.0%	4
Vichada	19.2%	30.6%	39.7%	8.7%	1.7%	229
Villavicencio	16.4%	24.2%	51.2%	7.0%	1.2%	3070
Yopal	16.9%	26.0%	49.2%	6.9%	0.9%	987
Yumbo	18.6%	24.6%	46.5%	8.5%	1.8%	737
Zipaquirá	12.6%	24.4%	56.1%	6.1%	0.8%	852
Colombia	17.4%	24.8%	47.7%	8.3%	1.8%	275339

*Es posible que los porcentajes mostrados no sumen exactamente 100 debido a aproximaciones decimales.

• **Pregunta 33.**

En las siguientes gráficas se muestra el registro de ventas de dos marcas de computadores, en un almacén durante una semana.



¿Cuál de las siguientes afirmaciones es verdadera?

- A. El martes se vendieron más computadores de la marca APER.
- B. El viernes se vendieron más computadores de la marca ACCES.
- C. El jueves se vendieron igual cantidad de computadores de ambas marcas.
- D. El lunes se vendieron menos computadores de la marca ACCES.

• **Estructura**

Competencia	Comunicación, representación y modelación
Componente	Aleatorio
Afirmación	Comparar, usar e interpretar datos que provienen de situaciones reales y traducir entre diferentes representaciones de un conjunto de datos.
Nivel de desempeño	Satisfactorio
Respuesta Correcta	D

• Resultados a nivel nacional y de Entidad Territorial Certificada (ETC)

ETC/País	A	B	C	D	Omisión y multimarca	N° estudiantes
Amazonas	35.4%	18.8%	12.2%	32.2%	1.5%	410
Antioquia	31.4%	14.3%	7.4%	46.2%	0.7%	13194
Apartadó	33.4%	19.3%	13.4%	33.8%	0.3%	779
Arauca	32.0%	12.8%	6.4%	48.3%	0.5%	1239
Armenia	30.7%	10.3%	5.1%	53.7%	0.2%	1846
Atlántico	35.8%	17.9%	8.1%	37.7%	0.5%	3385
Barrancabermeja	30.9%	13.0%	6.7%	49.0%	0.5%	1305
Barranquilla	32.7%	13.0%	6.3%	47.0%	0.9%	6501
Bello	30.3%	11.4%	6.9%	51.1%	0.4%	2366
Bogotá, D.C.	27.4%	7.9%	3.7%	58.5%	2.4%	46573
Bolívar	34.4%	19.8%	9.9%	35.1%	0.8%	5373
Boyacá	31.6%	10.0%	5.3%	52.9%	0.2%	5615
Bucaramanga	26.8%	7.0%	3.7%	62.2%	0.3%	3743
Buenaventura	34.5%	18.4%	9.5%	35.6%	2.0%	1742
Buga	29.9%	12.0%	6.1%	49.6%	2.4%	635
Caldas	32.6%	12.7%	6.2%	48.1%	0.4%	3340
Cali	32.7%	10.6%	5.5%	49.7%	1.5%	12346
Caquetá	32.0%	16.1%	6.0%	45.6%	0.4%	1125
Cartagena	33.0%	14.8%	7.7%	43.7%	0.8%	6521
Cartago	30.3%	9.9%	4.9%	53.9%	1.0%	608
Casanare	33.9%	11.7%	4.3%	49.5%	0.5%	1435
Cauca	36.4%	14.8%	7.6%	40.4%	0.9%	5697
Cesar	34.1%	16.5%	7.3%	41.8%	0.4%	3688
Chocó	33.1%	24.8%	13.4%	27.4%	1.2%	1409
Chía	27.0%	6.0%	3.4%	63.4%	0.2%	971
Ciénaga	32.0%	21.3%	11.4%	35.3%	0.0%	747
Cundinamarca	29.5%	8.9%	4.7%	56.4%	0.5%	9587
Córdoba	32.9%	20.8%	10.3%	35.0%	1.0%	6076
Cúcuta	30.7%	10.2%	4.8%	53.8%	0.5%	4355
Dosquebradas	28.9%	10.6%	5.4%	54.5%	0.6%	931
Duitama	25.7%	5.5%	3.0%	65.7%	0.1%	951
Envigado	24.4%	6.7%	5.3%	63.1%	0.6%	1332
Facatativá	28.4%	8.7%	3.5%	59.1%	0.3%	790
Florencia	31.3%	12.3%	6.1%	49.9%	0.3%	933
Floridablanca	29.3%	5.1%	3.4%	61.5%	0.8%	1552
Fusagasugá	31.3%	7.3%	5.7%	55.3%	0.5%	854
Girardot	34.5%	13.0%	5.9%	45.4%	1.2%	731

Continúa en la siguiente página

GRADO 9° - MATEMÁTICAS

ETC/País	A	B	C	D	Omisión y multimarca	N° estudiantes
Girón	31.0%	8.1%	3.8%	56.4%	0.7%	715
Guainía	0.0%	50.0%	0.0%	50.0%	0.0%	2
Guaviare	29.1%	18.2%	5.3%	45.3%	2.2%	495
Huila	33.3%	11.6%	5.4%	49.4%	0.3%	4002
Ibagué	30.9%	9.2%	4.7%	54.7%	0.5%	3312
Ipiales	34.0%	9.0%	5.4%	50.8%	0.8%	723
Itagüí	30.2%	12.4%	7.2%	48.9%	1.3%	1269
Jamundí	32.6%	15.1%	7.0%	44.7%	0.6%	684
La Guajira	29.0%	17.5%	7.8%	44.2%	1.5%	1356
Lorica	31.8%	23.7%	11.1%	33.0%	0.4%	931
Magangué	38.7%	15.7%	6.3%	39.0%	0.4%	752
Magdalena	33.5%	21.1%	11.2%	33.6%	0.6%	3733
Maicao	37.1%	17.4%	9.4%	34.8%	1.3%	850
Malambo	37.4%	17.9%	8.2%	35.2%	1.3%	559
Manizales	30.0%	10.6%	5.1%	54.0%	0.3%	2372
Medellín	29.7%	11.0%	5.8%	52.6%	0.9%	13276
Meta	32.6%	12.7%	5.5%	48.3%	0.9%	2485
Montería	33.9%	13.8%	6.9%	44.1%	1.3%	2838
Mosquera	28.2%	10.0%	6.2%	55.5%	0.1%	773
Nariño	34.5%	11.9%	5.3%	46.7%	1.6%	4307
Neiva	31.5%	9.3%	4.9%	54.0%	0.2%	2436
Norte de Santander	31.6%	11.7%	6.5%	49.8%	0.5%	3655
Palmira	32.8%	9.1%	5.3%	52.1%	0.7%	1675
Pasto	30.6%	8.3%	4.2%	56.7%	0.3%	2702
Pereira	30.6%	9.9%	5.2%	53.5%	0.8%	2788
Piedecuesta	28.5%	9.5%	5.5%	56.0%	0.5%	855
Pitalito	31.2%	9.9%	3.5%	55.3%	0.0%	765
Popayán	32.9%	9.0%	4.1%	53.2%	0.8%	1835
Putumayo	36.9%	12.2%	5.3%	44.8%	0.8%	1990
Quibdó	33.4%	19.5%	11.0%	33.2%	2.8%	879
Quindío	30.1%	12.0%	6.8%	50.6%	0.5%	1688
Riohacha	33.9%	17.6%	9.4%	38.7%	0.4%	959
Rionegro	31.0%	8.4%	5.1%	55.1%	0.5%	830
Risaralda	30.6%	13.6%	6.1%	49.1%	0.5%	1502
Sabaneta	24.4%	9.3%	4.0%	61.8%	0.5%	377
Sahagún	30.0%	19.3%	9.1%	41.1%	0.5%	791
San Andrés	32.8%	13.3%	8.5%	44.1%	1.4%	354
Santa Marta	32.3%	15.8%	8.2%	42.7%	1.0%	2901
Santander	29.2%	8.9%	4.1%	57.4%	0.4%	4609

Continúa en la siguiente página



ETC/País	A	B	C	D	Omisión y multimarca	N° estudiantes
Sincelejo	35.9%	13.8%	6.4%	43.7%	0.2%	2119
Soacha	31.9%	9.0%	4.4%	54.2%	0.5%	3301
Sogamoso	25.3%	7.8%	3.2%	63.6%	0.1%	964
Soledad	33.7%	13.9%	7.5%	44.5%	0.4%	2582
Sucre	33.2%	19.6%	9.6%	37.0%	0.6%	3941
Tolima	33.1%	14.6%	7.4%	44.5%	0.5%	5128
Tuluá	34.4%	14.1%	6.9%	44.1%	0.5%	1315
Tumaco	30.5%	19.3%	8.8%	40.7%	0.7%	872
Tunja	24.4%	8.2%	3.7%	62.7%	1.1%	1177
Turbo	35.6%	20.0%	11.2%	31.8%	1.4%	804
Uribe	32.2%	18.1%	12.8%	35.6%	1.3%	149
Valle del Cauca	34.4%	12.5%	6.5%	45.5%	1.0%	4711
Valledupar	33.4%	14.8%	6.6%	44.3%	1.0%	2687
Vaupés	25.0%	0.0%	0.0%	25.0%	50.0%	4
Vichada	38.0%	14.4%	6.6%	41.0%	0.0%	229
Villavicencio	28.8%	9.5%	5.5%	55.7%	0.5%	3070
Yopal	30.0%	9.7%	3.0%	57.0%	0.2%	987
Yumbo	34.1%	10.2%	5.4%	49.8%	0.5%	737
Zipaquirá	27.7%	8.5%	2.7%	61.0%	0.1%	852
Colombia	31.2%	12.0%	6.0%	49.8%	1.0%	275339

*Es posible que los porcentajes mostrados no sumen exactamente 100 debido a aproximaciones decimales.

• **Pregunta 34.**

Observa la casa de la figura.



¿Cuál es la vista de frente de esta casa?

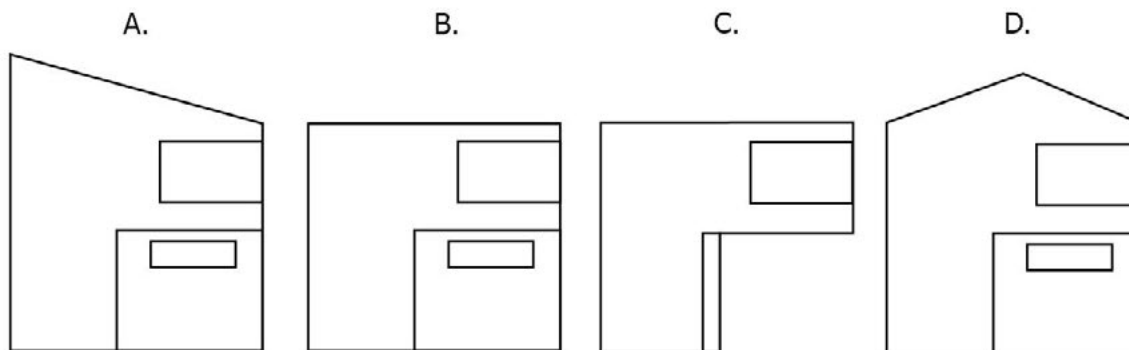

• **Estructura**

Competencia	Razonamiento y argumentación
Componente	Geométrico - métrico
Afirmación	Argumentar formal e informalmente sobre propiedades y relaciones de figuras planas y sólidos
Nivel de desempeño	Satisfactorio
Respuesta Correcta	B

• Resultados a nivel nacional y de Entidad Territorial Certificada (ETC)

ETC/País	A	B	C	D	Omisión y multimarca	N° estudiantes
Amazonas	10.0%	37.8%	29.0%	21.7%	1.5%	410
Antioquia	7.7%	42.3%	33.5%	15.8%	0.7%	13194
Apartadó	9.0%	42.4%	32.6%	15.7%	0.4%	779
Arauca	6.8%	44.4%	32.4%	15.8%	0.6%	1239
Armenia	5.7%	52.0%	30.0%	12.0%	0.3%	1846
Atlántico	8.5%	40.0%	36.3%	14.6%	0.6%	3385
Barrancabermeja	5.0%	51.0%	31.2%	12.3%	0.5%	1305
Barranquilla	6.6%	48.1%	32.9%	11.4%	1.0%	6501
Bello	7.9%	52.2%	28.7%	10.7%	0.5%	2366
Bogotá, D.C.	4.9%	58.6%	26.1%	8.0%	2.4%	46573
Bolívar	10.8%	34.6%	35.3%	18.5%	0.8%	5373
Boyacá	8.4%	46.4%	30.8%	14.2%	0.3%	5615
Bucaramanga	4.3%	59.7%	27.3%	8.5%	0.2%	3743
Buenaventura	8.0%	35.9%	35.2%	18.9%	2.0%	1742
Buga	6.3%	50.4%	29.0%	12.0%	2.4%	635
Caldas	7.3%	42.4%	33.1%	16.7%	0.5%	3340
Cali	6.1%	51.7%	29.8%	10.9%	1.5%	12346
Caquetá	8.1%	39.8%	31.0%	20.6%	0.4%	1125
Cartagena	7.7%	44.7%	32.5%	14.5%	0.7%	6521
Cartago	4.8%	50.7%	33.6%	10.0%	1.0%	608
Casanare	7.9%	41.7%	29.7%	20.2%	0.4%	1435
Cauca	7.1%	38.6%	32.9%	20.5%	0.9%	5697
Cesar	9.0%	37.5%	34.0%	19.1%	0.4%	3688
Chocó	10.3%	31.2%	37.0%	20.4%	1.2%	1409
Chía	4.0%	64.6%	25.3%	5.9%	0.2%	971
Ciénaga	7.2%	37.5%	41.4%	13.1%	0.8%	747
Cundinamarca	6.2%	52.1%	29.2%	12.0%	0.6%	9587
Córdoba	10.5%	33.8%	35.6%	19.1%	1.0%	6076
Cúcuta	5.6%	46.8%	34.0%	13.2%	0.4%	4355
Dosquebradas	5.4%	52.1%	30.0%	11.9%	0.6%	931
Duitama	6.5%	61.2%	24.6%	7.6%	0.1%	951
Envigado	4.5%	62.3%	25.8%	6.9%	0.5%	1332
Facatativá	6.2%	52.3%	31.6%	9.7%	0.1%	790
Florencia	6.1%	50.4%	28.9%	14.3%	0.3%	933
Floridablanca	5.0%	58.7%	27.1%	8.6%	0.6%	1552
Fusagasugá	7.5%	55.4%	28.5%	8.3%	0.4%	854
Girardot	5.7%	46.2%	34.9%	12.3%	0.8%	731

Continúa en la siguiente página

GRADO 9° - MATEMÁTICAS

ETC/País	A	B	C	D	Omisión y multimarca	N° estudiantes
Girón	6.0%	50.2%	31.0%	12.2%	0.6%	715
Guainía	0.0%	50.0%	50.0%	0.0%	0.0%	2
Guaviare	7.5%	36.4%	33.7%	20.4%	2.0%	495
Huila	7.6%	41.4%	34.4%	16.2%	0.3%	4002
Ibagué	6.2%	48.6%	32.0%	12.8%	0.5%	3312
Ipiales	5.4%	53.5%	26.8%	13.7%	0.6%	723
Itagüí	7.3%	49.2%	30.7%	11.7%	1.2%	1269
Jamundí	7.6%	45.0%	31.0%	16.2%	0.1%	684
La Guajira	11.4%	37.7%	32.0%	17.3%	1.6%	1356
Lorica	9.1%	34.5%	39.2%	16.8%	0.4%	931
Magangué	9.6%	38.0%	35.1%	16.8%	0.5%	752
Magdalena	11.4%	33.5%	35.6%	18.7%	0.7%	3733
Maicao	11.4%	38.2%	34.2%	14.5%	1.6%	850
Malambo	7.9%	41.9%	34.5%	15.0%	0.7%	559
Manizales	5.1%	51.8%	30.7%	12.1%	0.4%	2372
Medellín	7.1%	51.6%	29.8%	10.7%	0.8%	13276
Meta	7.3%	44.8%	30.1%	17.1%	0.8%	2485
Montería	8.5%	41.8%	33.7%	14.8%	1.3%	2838
Mosquera	7.1%	57.2%	25.2%	10.5%	0.0%	773
Nariño	7.4%	45.6%	28.3%	17.3%	1.5%	4307
Neiva	5.8%	50.1%	32.7%	11.2%	0.2%	2436
Norte de Santander	6.6%	45.0%	34.0%	13.9%	0.5%	3655
Palmira	5.7%	55.4%	28.4%	9.8%	0.7%	1675
Pasto	5.9%	56.7%	27.6%	9.4%	0.3%	2702
Pereira	5.8%	53.4%	29.3%	10.6%	0.8%	2788
Piedecuesta	5.6%	49.4%	29.7%	14.9%	0.5%	855
Pitalito	7.7%	51.2%	26.8%	14.0%	0.3%	765
Popayán	5.7%	52.8%	29.4%	11.2%	0.9%	1835
Putumayo	8.1%	44.6%	28.3%	18.4%	0.6%	1990
Quibdó	8.5%	34.1%	35.7%	19.0%	2.6%	879
Quindío	5.8%	45.5%	34.0%	14.4%	0.3%	1688
Riohacha	12.3%	40.1%	32.5%	14.6%	0.4%	959
Rionegro	6.7%	58.2%	24.9%	9.8%	0.4%	830
Risaralda	6.7%	43.9%	34.2%	14.6%	0.5%	1502
Sabaneta	4.8%	63.7%	25.7%	5.3%	0.5%	377
Sahagún	8.1%	36.8%	35.1%	19.7%	0.3%	791
San Andrés	9.0%	49.7%	29.4%	10.5%	1.4%	354
Santa Marta	7.3%	46.5%	31.0%	14.3%	0.8%	2901
Santander	6.2%	46.8%	32.3%	14.4%	0.3%	4609

Continúa en la siguiente página



ETC/País	A	B	C	D	Omisión y multimarca	N° estudiantes
Sincelejo	8.4%	43.8%	31.1%	16.4%	0.3%	2119
Soacha	6.3%	52.1%	30.8%	10.3%	0.5%	3301
Sogamoso	5.5%	61.9%	25.0%	7.6%	0.0%	964
Soledad	6.9%	49.5%	30.6%	12.7%	0.4%	2582
Sucre	10.7%	33.6%	36.7%	18.4%	0.6%	3941
Tolima	7.7%	39.2%	35.2%	17.5%	0.4%	5128
Tuluá	6.9%	46.4%	33.9%	12.2%	0.5%	1315
Tumaco	8.9%	38.6%	34.3%	17.2%	0.9%	872
Tunja	4.8%	61.5%	23.4%	9.3%	0.8%	1177
Turbo	10.8%	30.0%	37.7%	20.1%	1.4%	804
Uribe	12.1%	34.2%	37.6%	16.1%	0.0%	149
Valle del Cauca	6.2%	43.6%	35.1%	14.3%	0.8%	4711
Valledupar	8.5%	41.2%	32.9%	16.4%	1.0%	2687
Vaupés	0.0%	0.0%	25.0%	25.0%	50.0%	4
Vichada	11.8%	35.8%	28.8%	22.7%	0.9%	229
Villavicencio	5.5%	51.0%	30.1%	12.9%	0.5%	3070
Yopal	5.9%	53.2%	26.3%	14.4%	0.2%	987
Yumbo	4.2%	50.5%	34.3%	10.7%	0.3%	737
Zipaquirá	5.8%	59.0%	27.6%	7.5%	0.1%	852
Colombia	6.9%	48.2%	30.9%	13.1%	1.0%	275339

*Es posible que los porcentajes mostrados no sumen exactamente 100 debido a aproximaciones decimales.

• **Pregunta 35.**

Observa la figura que se muestra a continuación.

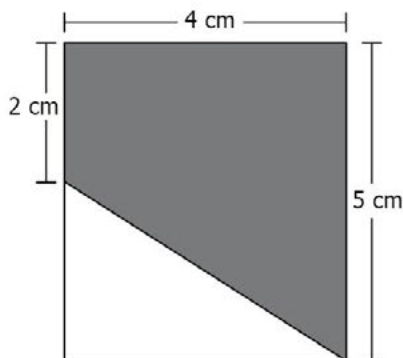

¿Cuál o cuáles de los siguientes procedimientos permite(n) hallar el área del trapecio sombreado?

$$\text{I. } (4 \text{ cm} \times 2 \text{ cm}) + \left[\frac{(4 \text{ cm} \times 3 \text{ cm})}{2} \right]$$

$$\text{II. } (4 \text{ cm} \times 5 \text{ cm}) - \left[\frac{(4 \text{ cm} \times 3 \text{ cm})}{2} \right]$$

$$\text{III. } (4 \text{ cm} \times 3 \text{ cm}) - \left[\frac{(4 \text{ cm} \times 3 \text{ cm})}{2} \right]$$

- A. I solamente.
 B. I y II solamente.
 C. II y III solamente.
 D. III solamente.

• **Estructura**

Competencia	Planteamiento y resolución de problemas
Componente	Geométrico - métrico
Afirmación	Establecer y utilizar diferentes procedimientos de cálculo para hallar medidas de superficies y volúmenes.
Nivel de desempeño	Avanzado
Respuesta Correcta	B

• **Resultados a nivel nacional y de Entidad Territorial Certificada (ETC)**

ETC/País	A	B	C	D	Omisión y multimarca	N° estudiantes
Amazonas	19.8%	38.0%	28.0%	11.7%	2.4%	410
Antioquia	22.2%	42.7%	20.5%	13.6%	1.0%	13194
Apartadó	19.1%	42.7%	22.3%	15.0%	0.8%	779
Arauca	25.0%	40.0%	19.9%	13.9%	1.2%	1239
Armenia	22.2%	43.4%	22.3%	11.4%	0.8%	1846
Atlántico	21.7%	41.9%	20.6%	14.7%	1.0%	3385
Barrancabermeja	22.0%	43.7%	22.4%	11.2%	0.8%	1305
Barranquilla	22.2%	44.3%	19.8%	12.1%	1.6%	6501
Bello	22.8%	45.8%	20.0%	10.6%	0.8%	2366
Bogotá, D.C.	21.7%	46.8%	19.0%	9.7%	2.9%	46573
Bolívar	19.5%	40.4%	24.1%	14.2%	1.7%	5373
Boyacá	22.0%	45.2%	21.1%	11.1%	0.6%	5615
Bucaramanga	22.4%	47.7%	18.3%	10.9%	0.7%	3743
Buenaventura	21.6%	38.1%	24.2%	13.7%	2.4%	1742
Buga	19.1%	42.7%	23.8%	11.5%	3.0%	635
Caldas	21.7%	42.6%	21.4%	13.5%	0.8%	3340
Cali	21.4%	44.8%	20.4%	11.2%	2.2%	12346
Caquetá	21.4%	45.1%	21.0%	11.9%	0.6%	1125
Cartagena	22.3%	43.0%	21.2%	12.3%	1.3%	6521
Cartago	22.5%	43.4%	19.7%	13.5%	0.8%	608
Casanare	22.0%	44.5%	20.9%	11.6%	1.0%	1435
Cauca	23.5%	41.8%	20.3%	13.1%	1.2%	5697
Cesar	21.8%	42.4%	20.7%	14.5%	0.6%	3688
Chocó	20.7%	37.8%	22.9%	16.8%	1.9%	1409
Chía	20.1%	45.6%	21.6%	11.9%	0.7%	971
Ciénaga	18.6%	41.5%	22.5%	16.3%	1.1%	747
Cundinamarca	22.1%	45.7%	20.4%	10.9%	0.9%	9587
Córdoba	20.3%	39.6%	23.5%	15.2%	1.4%	6076
Cúcuta	22.7%	47.3%	17.5%	11.7%	0.9%	4355
Dosquebradas	23.8%	43.1%	19.0%	12.7%	1.4%	931
Duitama	22.0%	53.5%	17.8%	6.1%	0.6%	951
Envigado	22.4%	44.7%	20.4%	11.3%	1.2%	1332
Facatativá	21.9%	42.7%	24.2%	10.6%	0.6%	790
Florencia	22.4%	47.9%	16.8%	11.8%	1.1%	933
Floridablanca	23.1%	47.6%	17.5%	10.8%	1.2%	1552
Fusagasugá	21.7%	47.0%	20.3%	10.5%	0.6%	854
Girardot	23.3%	42.8%	19.0%	12.9%	2.1%	731

Continúa en la siguiente página

GRADO 9° - MATEMÁTICAS

ETC/País	A	B	C	D	Omisión y multimarca	N° estudiantes
Girón	20.7%	49.7%	19.4%	9.4%	0.8%	715
Guainía	0.0%	0.0%	50.0%	50.0%	0.0%	2
Guaviare	24.2%	39.2%	21.0%	13.3%	2.2%	495
Huila	22.8%	45.4%	20.4%	11.0%	0.5%	4002
Ibagué	22.4%	45.0%	20.0%	11.4%	1.1%	3312
Ipiales	22.4%	48.0%	19.4%	9.4%	0.8%	723
Itagüí	23.6%	41.8%	20.6%	12.2%	1.8%	1269
Jamundí	25.0%	39.5%	20.0%	13.9%	1.6%	684
La Guajira	20.7%	42.8%	20.5%	14.0%	2.0%	1356
Lorica	21.1%	37.7%	23.4%	17.0%	0.9%	931
Magangué	19.0%	42.0%	22.5%	15.6%	0.9%	752
Magdalena	22.3%	38.7%	22.7%	15.2%	1.0%	3733
Maicao	22.9%	38.5%	23.5%	13.1%	2.0%	850
Malambo	22.7%	42.8%	19.9%	14.0%	0.7%	559
Manizales	22.6%	42.7%	21.3%	12.6%	0.9%	2372
Medellín	21.2%	43.8%	22.1%	11.6%	1.3%	13276
Meta	21.5%	45.1%	21.3%	11.0%	1.0%	2485
Montería	21.0%	44.9%	20.9%	11.7%	1.6%	2838
Mosquera	22.3%	44.8%	22.9%	10.1%	0.0%	773
Nariño	22.8%	42.9%	20.5%	11.6%	2.3%	4307
Neiva	22.4%	47.0%	19.7%	10.4%	0.5%	2436
Norte de Santander	22.8%	44.2%	20.3%	11.8%	0.9%	3655
Palmira	22.9%	44.2%	21.4%	10.2%	1.4%	1675
Pasto	23.9%	44.9%	18.9%	11.4%	1.0%	2702
Pereira	23.6%	42.5%	21.4%	11.3%	1.2%	2788
Piedecuesta	18.9%	49.5%	20.1%	10.5%	0.9%	855
Pitalito	22.2%	43.1%	21.2%	13.1%	0.4%	765
Popayán	22.9%	44.8%	19.9%	10.7%	1.6%	1835
Putumayo	21.8%	44.4%	21.2%	11.7%	1.0%	1990
Quibdó	19.9%	38.9%	22.8%	15.8%	2.6%	879
Quindío	21.9%	43.1%	22.6%	12.0%	0.4%	1688
Riohacha	22.7%	44.6%	20.6%	11.5%	0.5%	959
Rionegro	23.7%	43.4%	20.7%	11.3%	0.8%	830
Risaralda	23.0%	40.8%	22.4%	12.6%	1.1%	1502
Sabaneta	24.4%	44.3%	21.0%	9.8%	0.5%	377
Sahagún	21.4%	40.3%	25.2%	12.5%	0.6%	791
San Andrés	19.5%	41.2%	26.0%	11.6%	1.7%	354
Santa Marta	22.6%	41.0%	21.9%	13.0%	1.5%	2901
Santander	22.8%	46.3%	18.9%	11.5%	0.6%	4609

Continúa en la siguiente página



ETC/País	A	B	C	D	Omisión y multimarca	N° estudiantes
Sincelejo	22.1%	43.6%	21.4%	12.1%	0.7%	2119
Soacha	22.6%	45.3%	20.9%	10.3%	0.9%	3301
Sogamoso	22.5%	50.0%	18.8%	8.5%	0.2%	964
Soledad	24.5%	43.2%	20.2%	11.0%	1.0%	2582
Sucre	19.7%	41.1%	22.5%	15.7%	1.0%	3941
Tolima	20.7%	44.6%	20.9%	12.9%	0.9%	5128
Tuluá	22.1%	43.6%	22.8%	11.0%	0.5%	1315
Tumaco	21.6%	41.9%	20.3%	14.7%	1.6%	872
Tunja	22.7%	44.8%	22.7%	8.5%	1.4%	1177
Turbo	18.7%	44.0%	21.3%	13.9%	2.1%	804
Uribe	20.1%	51.0%	16.1%	12.1%	0.7%	149
Valle del Cauca	22.2%	44.4%	19.4%	12.5%	1.5%	4711
Valledupar	22.8%	41.2%	20.2%	14.4%	1.3%	2687
Vaupés	0.0%	25.0%	25.0%	0.0%	50.0%	4
Vichada	23.6%	42.4%	19.2%	13.1%	1.7%	229
Villavicencio	24.6%	43.3%	20.0%	11.2%	0.8%	3070
Yopal	21.7%	48.7%	19.3%	9.9%	0.4%	987
Yumbo	24.0%	43.4%	22.1%	9.9%	0.5%	737
Zipaquirá	19.4%	47.2%	21.9%	10.8%	0.7%	852
Colombia	22.0%	44.2%	20.6%	11.8%	1.5%	275339

*Es posible que los porcentajes mostrados no sumen exactamente 100 debido a aproximaciones decimales.

• **Pregunta 36.**

Un rectángulo se divide en cuatro regiones como lo muestra la siguiente figura.

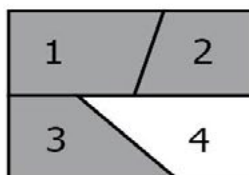

¿Cuál(es) de los siguientes procedimientos permite(n) calcular el área de la región sombreada?

- I. Sumar las áreas de las regiones 1, 2 y 3
- II. Hallar el área del rectángulo y restar el área de la región 4
- III. Sumar las áreas de las regiones 2, 3 y 4

- A. I solamente.
- B. II solamente.
- C. I y II solamente.
- D. I y III solamente.

• **Estructura**

Competencia	Planteamiento y resolución de problemas
Componente	Geométrico - métrico
Afirmación	Establecer y utilizar diferentes procedimientos de cálculo para hallar medidas de superficies y volúmenes.
Nivel de desempeño	Avanzado
Respuesta Correcta	C

• Resultados a nivel nacional y de Entidad Territorial Certificada (ETC)

ETC/País	A	B	C	D	Omisión y multimarca	N° estudiantes
Amazonas	21.5%	33.2%	23.2%	20.2%	2.0%	410
Antioquia	20.7%	35.3%	32.7%	10.5%	0.8%	13194
Apartadó	22.3%	36.1%	29.0%	12.1%	0.5%	779
Arauca	19.6%	36.3%	34.1%	9.3%	0.6%	1239
Armenia	18.7%	36.5%	35.3%	9.1%	0.4%	1846
Atlántico	24.9%	32.3%	28.7%	13.3%	0.8%	3385
Barrancabermeja	18.8%	34.6%	34.9%	11.3%	0.5%	1305
Barranquilla	22.2%	35.6%	31.6%	9.5%	1.0%	6501
Bello	20.2%	34.2%	36.6%	8.7%	0.4%	2366
Bogotá, D.C.	16.2%	31.4%	42.7%	7.2%	2.5%	46573
Bolívar	23.3%	32.6%	27.9%	15.2%	1.0%	5373
Boyacá	17.4%	37.0%	36.5%	8.8%	0.4%	5615
Bucaramanga	15.7%	34.5%	44.1%	5.5%	0.3%	3743
Buenaventura	22.2%	32.0%	28.6%	15.0%	2.2%	1742
Buga	18.9%	37.5%	33.9%	7.2%	2.5%	635
Caldas	22.1%	36.0%	31.1%	10.2%	0.6%	3340
Cali	18.8%	34.6%	36.3%	8.6%	1.7%	12346
Caquetá	19.6%	37.3%	30.1%	12.5%	0.4%	1125
Cartagena	23.5%	33.8%	31.0%	10.8%	0.8%	6521
Cartago	17.8%	37.0%	34.9%	9.5%	0.8%	608
Casanare	18.6%	37.2%	33.6%	10.1%	0.5%	1435
Cauca	21.5%	35.3%	30.7%	11.6%	0.8%	5697
Cesar	21.4%	34.3%	31.4%	12.5%	0.4%	3688
Chocó	23.6%	31.2%	24.4%	19.4%	1.3%	1409
Chía	13.0%	31.6%	48.9%	6.1%	0.4%	971
Ciénaga	22.5%	32.9%	30.5%	13.7%	0.4%	747
Cundinamarca	16.6%	34.7%	40.1%	8.0%	0.6%	9587
Córdoba	22.0%	33.9%	27.8%	15.4%	0.8%	6076
Cúcuta	20.3%	34.7%	36.8%	7.7%	0.5%	4355
Dosquebradas	17.4%	36.3%	35.1%	10.3%	0.9%	931
Duitama	11.0%	33.2%	49.6%	5.9%	0.2%	951
Envigado	14.9%	32.6%	46.4%	5.6%	0.5%	1332
Facatativá	14.9%	34.4%	42.5%	8.0%	0.1%	790
Florencia	15.2%	41.1%	35.4%	7.5%	0.9%	933
Floridablanca	15.1%	35.6%	41.4%	7.3%	0.6%	1552
Fusagasugá	17.7%	35.2%	40.2%	6.7%	0.2%	854
Girardot	19.0%	36.0%	32.8%	11.2%	1.0%	731

Continúa en la siguiente página

GRADO 9° - MATEMÁTICAS

ETC/País	A	B	C	D	Omisión y multimarca	N° estudiantes
Girón	18.9%	37.5%	35.1%	7.8%	0.7%	715
Guainía	50.0%	50.0%	0.0%	0.0%	0.0%	2
Guaviare	19.2%	40.0%	28.1%	10.5%	2.2%	495
Huila	20.0%	37.4%	33.1%	9.1%	0.3%	4002
Ibagué	19.8%	34.8%	36.8%	8.0%	0.6%	3312
Ipiales	19.8%	29.7%	41.8%	8.3%	0.4%	723
Itagüí	22.5%	29.6%	36.6%	9.5%	1.7%	1269
Jamundí	24.9%	33.2%	30.8%	10.4%	0.7%	684
La Guajira	20.5%	34.5%	30.8%	12.6%	1.5%	1356
Lorica	24.4%	31.0%	27.2%	16.9%	0.5%	931
Magangué	24.1%	36.0%	26.3%	12.6%	0.9%	752
Magdalena	24.6%	32.6%	26.5%	15.5%	0.9%	3733
Maicao	24.5%	35.9%	24.2%	13.9%	1.5%	850
Malambo	24.3%	37.4%	26.8%	10.6%	0.9%	559
Manizales	18.8%	36.3%	36.8%	7.5%	0.6%	2372
Medellín	19.4%	33.5%	37.0%	9.1%	1.0%	13276
Meta	20.2%	35.8%	32.9%	10.1%	0.9%	2485
Montería	21.8%	34.0%	30.2%	12.6%	1.4%	2838
Mosquera	17.2%	32.9%	41.0%	8.7%	0.3%	773
Nariño	19.0%	34.3%	36.7%	8.3%	1.7%	4307
Neiva	19.6%	34.7%	38.7%	6.7%	0.3%	2436
Norte de Santander	20.5%	35.6%	34.6%	8.8%	0.5%	3655
Palmira	18.9%	33.7%	39.2%	7.2%	1.0%	1675
Pasto	17.1%	32.1%	42.8%	7.5%	0.4%	2702
Pereira	18.3%	37.2%	35.6%	8.2%	0.7%	2788
Piedecuesta	16.4%	38.1%	36.4%	8.4%	0.7%	855
Pitalito	20.3%	38.4%	32.2%	9.0%	0.1%	765
Popayán	16.3%	35.3%	39.7%	7.5%	1.2%	1835
Putumayo	17.9%	36.3%	36.2%	9.0%	0.6%	1990
Quibdó	21.8%	31.7%	29.1%	14.6%	2.7%	879
Quindío	19.4%	39.3%	31.5%	9.5%	0.2%	1688
Riohacha	24.2%	35.1%	27.7%	12.6%	0.3%	959
Rionegro	19.6%	32.8%	40.8%	6.4%	0.4%	830
Risaralda	20.6%	38.1%	30.1%	10.6%	0.6%	1502
Sabaneta	15.1%	33.2%	43.8%	6.9%	1.1%	377
Sahagún	20.6%	36.5%	28.8%	13.8%	0.3%	791
San Andrés	24.9%	34.2%	29.7%	9.6%	1.7%	354
Santa Marta	24.2%	33.5%	29.9%	11.3%	1.1%	2901
Santander	18.1%	36.0%	37.8%	7.9%	0.3%	4609

Continúa en la siguiente página



ETC/País	A	B	C	D	Omisión y multimarca	N° estudiantes
Sincelejo	21.1%	36.3%	32.8%	9.2%	0.5%	2119
Soacha	20.9%	31.3%	38.1%	9.1%	0.6%	3301
Sogamoso	15.0%	36.3%	42.2%	6.4%	0.0%	964
Soledad	25.3%	33.7%	30.7%	9.6%	0.7%	2582
Sucre	21.8%	35.0%	27.9%	14.8%	0.6%	3941
Tolima	20.7%	34.9%	32.6%	11.3%	0.5%	5128
Tuluá	21.2%	35.7%	31.8%	11.0%	0.4%	1315
Tumaco	22.6%	34.2%	28.0%	14.1%	1.1%	872
Tunja	17.7%	30.5%	44.0%	6.9%	0.9%	1177
Turbo	23.6%	32.6%	25.4%	16.0%	2.4%	804
Uribe	26.2%	34.2%	26.8%	12.1%	0.7%	149
Valle del Cauca	20.3%	36.0%	31.6%	11.0%	1.1%	4711
Valledupar	20.7%	36.3%	30.3%	11.6%	1.1%	2687
Vaupés	0.0%	25.0%	25.0%	0.0%	50.0%	4
Vichada	22.7%	34.9%	28.4%	12.7%	1.3%	229
Villavicencio	20.4%	35.1%	36.9%	7.1%	0.5%	3070
Yopal	19.1%	33.7%	39.9%	7.1%	0.1%	987
Yumbo	18.6%	34.6%	37.6%	8.3%	0.9%	737
Zipacquirá	13.5%	34.7%	44.0%	7.5%	0.2%	852
Colombia	19.5%	34.2%	35.7%	9.6%	1.1%	275339

*Es posible que los porcentajes mostrados no sumen exactamente 100 debido a aproximaciones decimales.

• **Pregunta 37.**

Camila realiza una tarea para su clase de Artes. Ella recorta una figura rectangular que tiene 22 cm de perímetro y 30 cm^2 de área.

¿Cuál de las siguientes figuras recortó Camila?

A.

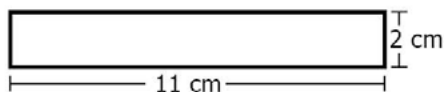

B.

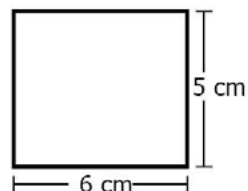

C.

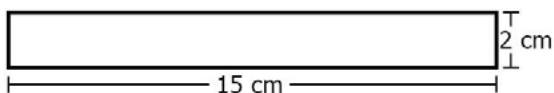

D.

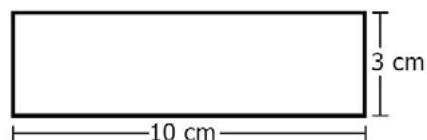

• **Estructura**

Competencia	Comunicación, representación y modelación
Componente	Geométrico - métrico
Afirmación	Diferenciar magnitudes de un objeto y relacionar las dimensiones de éste con la determinación de las magnitudes
Nivel de desempeño	Avanzado
Respuesta Correcta	B

• Resultados a nivel nacional y de Entidad Territorial Certificada (ETC)

ETC/País	A	B	C	D	Omisión y multimarca	N° estudiantes
Amazonas	18.3%	19.5%	31.0%	29.3%	2.0%	410
Antioquia	18.8%	30.1%	27.2%	22.9%	1.1%	13194
Apartadó	19.6%	26.4%	27.2%	25.9%	0.8%	779
Arauca	22.8%	28.5%	24.6%	23.3%	0.8%	1239
Armenia	18.5%	31.1%	25.0%	24.8%	0.6%	1846
Atlántico	18.6%	25.6%	29.6%	25.2%	0.9%	3385
Barrancabermeja	18.2%	31.0%	28.7%	21.1%	1.0%	1305
Barranquilla	20.5%	29.0%	27.5%	21.6%	1.5%	6501
Bello	21.6%	29.2%	26.6%	21.9%	0.6%	2366
Bogotá, D.C.	18.6%	36.2%	22.7%	19.8%	2.7%	46573
Bolívar	17.8%	27.4%	29.8%	23.7%	1.2%	5373
Boyacá	20.5%	32.1%	24.8%	22.1%	0.4%	5615
Bucaramanga	18.0%	40.4%	20.3%	20.5%	0.7%	3743
Buenaventura	21.1%	24.1%	29.0%	23.2%	2.6%	1742
Buga	18.7%	31.2%	25.8%	21.3%	3.0%	635
Caldas	19.7%	25.8%	28.5%	25.2%	0.7%	3340
Cali	18.5%	33.0%	24.7%	21.8%	1.9%	12346
Caquetá	20.0%	32.4%	25.0%	21.8%	0.8%	1125
Cartagena	18.9%	27.9%	29.9%	22.1%	1.2%	6521
Cartago	20.1%	29.6%	27.1%	21.9%	1.3%	608
Casanare	18.6%	29.5%	27.1%	24.2%	0.6%	1435
Cauca	19.0%	30.5%	26.9%	22.3%	1.3%	5697
Cesar	20.2%	25.9%	28.8%	24.3%	0.8%	3688
Chocó	18.7%	25.0%	30.8%	24.3%	1.1%	1409
Chía	16.9%	42.8%	20.3%	19.7%	0.3%	971
Ciénaga	20.3%	22.0%	35.1%	22.1%	0.5%	747
Cundinamarca	19.8%	32.8%	24.1%	22.5%	0.8%	9587
Córdoba	19.2%	27.0%	29.8%	23.0%	1.0%	6076
Cúcuta	19.8%	34.6%	24.6%	20.3%	0.7%	4355
Dosquebradas	18.6%	30.3%	26.0%	24.3%	0.9%	931
Duitama	19.3%	49.3%	14.9%	16.2%	0.2%	951
Envigado	15.4%	44.5%	21.7%	17.6%	0.8%	1332
Facatativá	20.3%	35.7%	23.2%	20.8%	0.1%	790
Florencia	19.7%	26.0%	28.0%	25.5%	0.8%	933
Floridablanca	17.8%	40.6%	21.6%	19.0%	0.9%	1552
Fusagasugá	19.4%	31.7%	22.8%	25.1%	0.9%	854
Girardot	19.3%	24.4%	33.1%	22.3%	1.0%	731

Continúa en la siguiente página

GRADO 9° - MATEMÁTICAS

ETC/País	A	B	C	D	Omisión y multimarca	N° estudiantes
Girón	19.0%	33.7%	24.3%	22.2%	0.7%	715
Guainía	0.0%	50.0%	0.0%	50.0%	0.0%	2
Guaviare	18.6%	23.8%	26.7%	27.7%	3.2%	495
Huila	20.8%	29.2%	26.0%	23.5%	0.4%	4002
Ibagué	17.6%	32.9%	25.1%	23.5%	0.9%	3312
Ipiales	19.6%	33.2%	26.3%	19.9%	1.0%	723
Itagüí	19.6%	30.2%	25.2%	23.3%	1.7%	1269
Jamundí	22.5%	26.6%	29.2%	20.5%	1.2%	684
La Guajira	21.5%	27.5%	27.5%	21.5%	1.9%	1356
Lorica	16.9%	26.9%	34.5%	20.7%	1.1%	931
Magangué	22.6%	21.3%	31.0%	23.5%	1.6%	752
Magdalena	19.6%	24.1%	30.8%	24.5%	1.0%	3733
Maicao	17.6%	22.9%	34.0%	23.3%	2.1%	850
Malambo	16.3%	28.4%	31.5%	22.5%	1.3%	559
Manizales	19.8%	28.3%	26.9%	24.5%	0.5%	2372
Medellín	19.6%	31.3%	26.9%	21.1%	1.2%	13276
Meta	20.2%	28.3%	25.9%	24.6%	1.0%	2485
Montería	19.5%	27.1%	28.5%	23.2%	1.7%	2838
Mosquera	19.4%	32.7%	25.6%	21.6%	0.6%	773
Nariño	18.9%	33.7%	25.3%	20.0%	2.1%	4307
Neiva	20.0%	34.5%	23.2%	21.8%	0.5%	2436
Norte de Santander	18.8%	31.1%	26.7%	22.6%	0.7%	3655
Palmira	17.9%	36.8%	24.8%	19.2%	1.3%	1675
Pasto	18.4%	40.8%	20.3%	19.8%	0.7%	2702
Pereira	19.3%	30.1%	26.6%	22.7%	1.2%	2788
Piedecuesta	21.8%	34.5%	22.9%	20.1%	0.7%	855
Pitalito	20.1%	27.1%	29.2%	22.9%	0.8%	765
Popayán	18.9%	36.2%	22.8%	20.6%	1.5%	1835
Putumayo	19.7%	32.7%	25.4%	21.3%	0.9%	1990
Quibdó	17.2%	22.3%	31.6%	25.1%	3.8%	879
Quindío	20.5%	29.7%	26.9%	22.4%	0.5%	1688
Riohacha	20.8%	24.0%	30.8%	23.9%	0.6%	959
Rionegro	20.2%	33.7%	25.2%	20.4%	0.5%	830
Risaralda	22.2%	24.6%	28.6%	23.7%	0.9%	1502
Sabaneta	18.0%	43.2%	18.3%	19.6%	0.8%	377
Sahagún	16.7%	30.8%	27.2%	24.7%	0.6%	791
San Andrés	20.3%	22.3%	28.8%	26.8%	1.7%	354
Santa Marta	20.4%	26.7%	30.5%	20.8%	1.6%	2901
Santander	19.4%	34.5%	24.7%	20.8%	0.6%	4609

Continúa en la siguiente página



ETC/País	A	B	C	D	Omisión y multimarca	N° estudiantes
Sincelejo	18.8%	31.4%	27.0%	22.2%	0.6%	2119
Soacha	20.2%	28.9%	26.6%	23.8%	0.5%	3301
Sogamoso	18.5%	39.1%	19.6%	22.5%	0.3%	964
Soledad	20.4%	27.3%	29.4%	22.3%	0.7%	2582
Sucre	18.5%	26.0%	30.6%	23.7%	1.2%	3941
Tolima	20.3%	26.8%	28.2%	24.2%	0.5%	5128
Tuluá	20.9%	26.4%	29.3%	22.8%	0.6%	1315
Tumaco	21.6%	25.6%	27.8%	24.2%	0.9%	872
Tunja	20.3%	38.3%	21.4%	19.0%	0.9%	1177
Turbo	16.3%	24.0%	35.0%	22.4%	2.4%	804
Uribe	18.8%	18.1%	26.2%	36.2%	0.7%	149
Valle del Cauca	19.8%	24.8%	29.7%	24.4%	1.4%	4711
Valledupar	20.1%	24.5%	29.0%	25.0%	1.4%	2687
Vaupés	25.0%	0.0%	25.0%	0.0%	50.0%	4
Vichada	19.7%	22.7%	27.5%	28.4%	1.7%	229
Villavicencio	19.1%	35.3%	24.6%	20.3%	0.7%	3070
Yopal	19.9%	38.7%	21.3%	20.0%	0.2%	987
Yumbo	19.7%	32.0%	25.4%	21.8%	1.1%	737
Zipaquirá	17.0%	42.1%	20.3%	19.6%	0.9%	852
Colombia	19.2%	31.4%	26.0%	22.0%	1.3%	275339

*Es posible que los porcentajes mostrados no sumen exactamente 100 debido a aproximaciones decimales.

• **Pregunta 38.**

En las expresiones algebraicas que aparecen a continuación x y y son números reales cualesquiera.

$$(x + y)^2$$

(1)

$$x^2 + 2xy + y^2$$

(2)

$$x^2 + x^2$$

(3)

Si $x = 2$ y $y = 3$, $(x + y)^2$ es igual a

- A. 9
- B. 10
- C. 13
- D. 25

• **Estructura**

Competencia	Comunicación, representación y modelación
Componente	Numérico - variacional
Afirmación	Identificar expresiones numéricas y algebraicas equivalentes
Nivel de desempeño	Avanzado
Respuesta Correcta	D

• Resultados a nivel nacional y de Entidad Territorial Certificada (ETC)

ETC/País	A	B	C	D	Omisión y multimarca	N° estudiantes
Amazonas	20.7%	35.6%	15.9%	25.1%	2.7%	410
Antioquia	17.6%	32.2%	18.7%	30.4%	1.2%	13194
Apartadó	19.1%	35.9%	19.9%	24.4%	0.6%	779
Arauca	14.7%	31.9%	19.9%	32.7%	0.8%	1239
Armenia	12.7%	32.2%	17.7%	36.6%	0.9%	1846
Atlántico	24.0%	35.2%	16.4%	23.3%	1.0%	3385
Barrancabermeja	18.0%	30.3%	19.2%	31.2%	1.2%	1305
Barranquilla	16.3%	30.5%	18.8%	33.1%	1.3%	6501
Bello	15.0%	31.7%	18.9%	33.7%	0.7%	2366
Bogotá, D.C.	9.8%	29.8%	15.3%	42.3%	2.7%	46573
Bolívar	23.3%	33.7%	18.6%	22.7%	1.7%	5373
Boyacá	13.1%	33.2%	18.7%	34.5%	0.5%	5615
Bucaramanga	8.9%	24.7%	21.1%	44.9%	0.5%	3743
Buenaventura	23.2%	37.0%	14.7%	21.9%	3.2%	1742
Buga	15.9%	35.0%	18.9%	27.1%	3.1%	635
Caldas	16.6%	32.5%	18.4%	31.6%	0.8%	3340
Cali	14.0%	30.7%	17.5%	35.7%	2.1%	12346
Caquetá	16.9%	34.0%	19.6%	29.2%	0.4%	1125
Cartagena	17.9%	32.4%	18.5%	29.8%	1.5%	6521
Cartago	14.5%	31.4%	14.3%	38.8%	1.0%	608
Casanare	13.9%	35.6%	16.2%	33.1%	1.3%	1435
Cauca	18.3%	29.7%	20.1%	30.3%	1.5%	5697
Cesar	19.9%	32.9%	17.8%	28.6%	0.9%	3688
Chocó	27.0%	33.0%	18.4%	19.1%	2.5%	1409
Chía	10.0%	24.0%	16.6%	48.8%	0.6%	971
Ciénaga	22.1%	36.8%	17.0%	22.1%	2.0%	747
Cundinamarca	12.4%	32.4%	17.7%	36.6%	0.9%	9587
Córdoba	23.7%	32.5%	17.4%	25.0%	1.3%	6076
Cúcuta	13.4%	30.1%	19.8%	35.8%	0.9%	4355
Dosquebradas	10.3%	26.0%	21.6%	41.2%	0.9%	931
Duitama	8.2%	20.7%	23.9%	46.9%	0.3%	951
Envigado	8.5%	22.2%	18.9%	49.2%	1.1%	1332
Facatativá	11.8%	32.9%	17.7%	37.0%	0.6%	790
Florencia	14.8%	35.6%	19.0%	29.4%	1.3%	933
Floridablanca	11.0%	23.5%	22.4%	42.4%	0.8%	1552
Fusagasugá	12.4%	31.6%	19.8%	35.5%	0.7%	854
Girardot	18.3%	31.6%	13.4%	34.9%	1.8%	731

Continúa en la siguiente página

GRADO 9° - MATEMÁTICAS

ETC/País	A	B	C	D	Omisión y multimarca	N° estudiantes
Girón	11.0%	31.2%	21.1%	35.5%	1.1%	715
Guainía	50.0%	0.0%	50.0%	0.0%	0.0%	2
Guaviare	18.4%	32.9%	19.8%	26.5%	2.4%	495
Huila	15.9%	33.6%	19.1%	30.9%	0.6%	4002
Ibagué	12.6%	32.7%	18.0%	35.9%	0.8%	3312
Ipiales	10.2%	23.7%	21.9%	43.7%	0.6%	723
Itagüí	15.3%	33.0%	17.3%	32.6%	1.8%	1269
Jamundí	18.6%	35.8%	20.0%	24.9%	0.7%	684
La Guajira	21.1%	32.4%	21.3%	22.9%	2.3%	1356
Lorica	25.8%	36.0%	16.8%	20.8%	0.6%	931
Magangué	22.3%	30.9%	18.4%	27.3%	1.2%	752
Magdalena	26.1%	34.3%	17.0%	21.2%	1.4%	3733
Maicao	20.6%	35.8%	17.4%	23.5%	2.7%	850
Malambo	22.5%	37.0%	13.1%	26.3%	1.1%	559
Manizales	12.9%	28.3%	22.5%	35.7%	0.6%	2372
Medellín	14.0%	30.6%	18.8%	35.2%	1.3%	13276
Meta	16.4%	35.5%	18.1%	28.9%	1.1%	2485
Montería	19.0%	33.1%	18.2%	27.7%	2.0%	2838
Mosquera	11.1%	33.8%	14.4%	40.8%	0.0%	773
Nariño	13.7%	25.2%	21.8%	37.3%	2.1%	4307
Neiva	13.0%	28.0%	20.4%	38.1%	0.5%	2436
Norte de Santander	15.6%	29.3%	21.9%	32.4%	0.7%	3655
Palmira	12.3%	30.7%	17.6%	38.1%	1.3%	1675
Pasto	9.4%	22.7%	21.9%	45.2%	0.7%	2702
Pereira	12.1%	30.3%	19.2%	37.2%	1.3%	2788
Piedecuesta	10.5%	30.4%	21.8%	36.7%	0.6%	855
Pitalito	13.5%	28.5%	20.5%	37.0%	0.5%	765
Popayán	9.2%	25.2%	19.7%	44.2%	1.7%	1835
Putumayo	14.8%	28.3%	22.4%	33.5%	1.1%	1990
Quibdó	21.0%	32.5%	22.0%	21.4%	3.1%	879
Quindío	15.9%	32.6%	18.1%	32.8%	0.7%	1688
Riohacha	20.2%	34.3%	21.2%	23.0%	1.3%	959
Rionegro	12.9%	31.3%	18.9%	36.1%	0.7%	830
Risaralda	16.0%	30.2%	20.6%	32.1%	1.0%	1502
Sabaneta	11.7%	24.4%	19.4%	43.2%	1.3%	377
Sahagún	21.4%	36.9%	17.7%	23.3%	0.8%	791
San Andrés	16.7%	29.9%	20.6%	30.5%	2.3%	354
Santa Marta	18.2%	35.4%	18.5%	26.3%	1.6%	2901
Santander	12.1%	29.2%	19.5%	38.8%	0.5%	4609

Continúa en la siguiente página



ETC/País	A	B	C	D	Omisión y multimarca	N° estudiantes
Sincelejo	16.1%	30.9%	19.7%	32.7%	0.7%	2119
Soacha	12.1%	35.8%	16.8%	34.4%	0.8%	3301
Sogamoso	9.6%	28.2%	21.4%	40.7%	0.1%	964
Soledad	17.8%	34.3%	16.1%	30.9%	0.9%	2582
Sucre	23.6%	30.7%	18.3%	26.0%	1.3%	3941
Tolima	18.4%	34.3%	18.4%	28.0%	0.9%	5128
Tuluá	16.3%	36.1%	17.3%	29.4%	0.9%	1315
Tumaco	17.5%	32.3%	21.0%	27.4%	1.7%	872
Tunja	8.5%	26.5%	16.7%	47.3%	1.0%	1177
Turbo	25.9%	33.1%	18.0%	19.5%	3.5%	804
Uribe	24.2%	45.0%	16.1%	14.8%	0.0%	149
Valle del Cauca	17.5%	34.4%	17.4%	29.2%	1.4%	4711
Valledupar	19.1%	35.7%	17.9%	25.8%	1.6%	2687
Vaupés	0.0%	25.0%	0.0%	25.0%	50.0%	4
Vichada	21.4%	38.0%	16.6%	21.8%	2.2%	229
Villavicencio	11.2%	30.6%	20.2%	37.3%	0.7%	3070
Yopal	14.4%	32.8%	16.8%	35.4%	0.6%	987
Yumbo	15.5%	35.0%	17.0%	31.1%	1.5%	737
Zipaquirá	10.6%	27.0%	17.3%	45.0%	0.2%	852
Colombia	15.0%	31.2%	18.2%	34.1%	1.5%	275339

*Es posible que los porcentajes mostrados no sumen exactamente 100 debido a aproximaciones decimales.

• **Pregunta 39.**

En el colegio "Nuevo País", los 200 estudiantes de primaria y los 300 de secundaria votaron para elegir al Personero de los estudiantes.

En la tabla 1 y en la tabla 2 se presenta información sobre los resultados.

Tabla 1

PORCENTAJE DE VOTACIÓN EN TODO EL COLEGIO	
Votos	Porcentaje de votantes
En blanco	20%
Nulos	10%
Candidato F	30%
Candidato G	40%

Tabla 2

RESULTADOS EN PRIMARIA	
Votos	Nº de votantes
En blanco	10
Nulos	40
Candidato F	90
Candidato G	60

¿Cuántos votos obtuvo el candidato G en secundaria?

- A. 40
- B. 60
- C. 140
- D. 200

• **Estructura**

Competencia	Planteamiento y resolución de problemas
Componente	Numérico - variacional
Afirmación	Resolver problemas en situaciones aditivas y multiplicativas en el conjunto de los números reales.
Nivel de desempeño	Avanzado
Respuesta Correcta	C

• Resultados a nivel nacional y de Entidad Territorial Certificada (ETC)

ETC/País	A	B	C	D	Omisión y multimarca	Nº estudiantes
Amazonas	25.1%	30.2%	27.6%	13.7%	3.4%	410
Antioquia	28.7%	25.0%	34.3%	10.8%	1.1%	13194
Apartadó	26.2%	29.7%	31.7%	11.7%	0.8%	779
Arauca	26.6%	26.8%	36.2%	9.8%	0.6%	1239
Armenia	28.7%	24.4%	36.0%	10.3%	0.7%	1846
Atlántico	28.2%	26.8%	31.8%	12.3%	0.9%	3385
Barrancabermeja	26.2%	24.9%	36.2%	12.0%	0.8%	1305
Barranquilla	27.7%	25.4%	34.8%	10.8%	1.3%	6501
Bello	29.5%	23.2%	37.0%	9.8%	0.6%	2366
Bogotá, D.C.	24.7%	22.8%	39.7%	9.8%	2.9%	46573
Bolívar	28.2%	29.1%	28.1%	13.1%	1.4%	5373
Boyacá	25.9%	24.4%	37.8%	11.2%	0.6%	5615
Bucaramanga	23.7%	22.3%	42.8%	10.6%	0.7%	3743
Buenaventura	28.8%	30.7%	26.8%	11.1%	2.6%	1742
Buga	25.5%	23.3%	37.0%	11.5%	2.7%	635
Caldas	28.9%	25.6%	34.7%	10.1%	0.7%	3340
Cali	26.2%	25.5%	35.7%	10.5%	2.1%	12346
Caquetá	27.0%	26.8%	33.2%	12.2%	0.7%	1125
Cartagena	27.2%	25.4%	34.0%	12.2%	1.2%	6521
Cartago	27.6%	26.2%	36.2%	8.9%	1.2%	608
Casanare	26.2%	25.4%	36.6%	10.7%	1.1%	1435
Cauca	28.8%	26.2%	31.3%	12.3%	1.4%	5697
Cesar	28.8%	26.5%	31.7%	12.6%	0.4%	3688
Chocó	29.1%	28.5%	27.0%	13.8%	1.6%	1409
Chía	22.8%	20.5%	45.2%	10.8%	0.7%	971
Ciénaga	26.1%	29.5%	30.0%	13.8%	0.7%	747
Cundinamarca	26.0%	23.3%	38.7%	11.1%	0.9%	9587
Córdoba	26.2%	29.3%	31.5%	11.9%	1.1%	6076
Cúcuta	29.3%	23.6%	35.3%	11.0%	0.8%	4355
Dosquebradas	27.7%	25.6%	35.1%	10.6%	1.0%	931
Duitama	23.9%	22.4%	44.3%	8.9%	0.5%	951
Envigado	23.3%	18.7%	45.2%	11.5%	1.3%	1332
Facatativá	27.0%	24.9%	37.3%	10.6%	0.1%	790
Florencia	26.4%	26.0%	37.9%	9.1%	0.5%	933
Floridablanca	24.4%	20.2%	43.5%	10.9%	1.0%	1552
Fusagasugá	25.9%	23.2%	39.0%	11.1%	0.8%	854
Girardot	24.8%	28.6%	34.2%	11.2%	1.2%	731

Continúa en la siguiente página

GRADO 9° - MATEMÁTICAS

ETC/País	A	B	C	D	Omisión y multimarca	N° estudiantes
Girón	27.1%	23.6%	37.8%	10.6%	0.8%	715
Guainía	0.0%	0.0%	50.0%	50.0%	0.0%	2
Guaviare	26.5%	25.1%	34.3%	11.5%	2.6%	495
Huila	30.4%	24.2%	33.8%	10.9%	0.6%	4002
Ibagué	27.7%	23.0%	38.1%	10.4%	0.8%	3312
Ipiales	28.4%	19.6%	38.7%	12.9%	0.4%	723
Itagüí	28.8%	23.0%	35.1%	11.3%	1.7%	1269
Jamundí	27.5%	27.6%	33.8%	10.5%	0.6%	684
La Guajira	24.4%	27.7%	33.6%	12.4%	2.0%	1356
Lorica	30.2%	30.6%	26.4%	12.0%	0.8%	931
Magangué	31.9%	26.9%	28.7%	11.6%	0.9%	752
Magdalena	28.2%	29.9%	28.1%	12.9%	0.9%	3733
Maicao	28.1%	28.6%	29.4%	12.2%	1.6%	850
Malambo	25.4%	26.7%	35.1%	11.8%	1.1%	559
Manizales	27.8%	23.6%	37.6%	10.5%	0.5%	2372
Medellín	27.5%	23.9%	36.5%	10.9%	1.2%	13276
Meta	27.7%	25.6%	34.2%	11.5%	1.0%	2485
Montería	28.5%	24.8%	33.1%	12.0%	1.7%	2838
Mosquera	28.1%	25.6%	35.7%	10.1%	0.5%	773
Nariño	29.0%	22.7%	33.7%	12.7%	1.8%	4307
Neiva	30.1%	22.7%	36.4%	10.6%	0.2%	2436
Norte de Santander	29.9%	23.1%	34.5%	11.8%	0.7%	3655
Palmira	25.9%	23.3%	36.6%	12.5%	1.7%	1675
Pasto	27.6%	22.5%	39.2%	10.2%	0.6%	2702
Pereira	26.9%	22.6%	37.9%	11.4%	1.1%	2788
Piedecuesta	24.3%	25.4%	38.6%	10.8%	0.9%	855
Pitalito	29.7%	23.7%	33.9%	12.2%	0.7%	765
Popayán	24.3%	24.6%	39.2%	10.1%	1.8%	1835
Putumayo	28.3%	23.2%	35.1%	12.7%	0.7%	1990
Quibdó	29.6%	29.9%	26.6%	11.3%	2.6%	879
Quindío	25.9%	27.1%	36.3%	10.5%	0.3%	1688
Riohacha	32.3%	26.2%	29.5%	11.1%	0.9%	959
Rionegro	28.1%	21.3%	38.1%	11.3%	1.2%	830
Risaralda	28.6%	26.0%	34.2%	10.6%	0.6%	1502
Sabaneta	24.1%	19.9%	44.6%	9.5%	1.9%	377
Sahagún	27.4%	28.4%	31.2%	12.4%	0.5%	791
San Andrés	24.6%	26.3%	36.7%	11.0%	1.4%	354
Santa Marta	26.4%	28.2%	33.6%	10.7%	1.1%	2901
Santander	25.6%	22.4%	39.6%	11.8%	0.7%	4609

Continúa en la siguiente página



ETC/País	A	B	C	D	Omisión y multimarca	N° estudiantes
Sincelejo	26.5%	25.2%	37.2%	10.4%	0.7%	2119
Soacha	28.2%	26.1%	34.6%	10.5%	0.6%	3301
Sogamoso	26.8%	24.4%	38.6%	10.2%	0.1%	964
Soledad	27.3%	27.3%	33.4%	11.2%	0.8%	2582
Sucre	26.5%	28.1%	31.6%	13.2%	0.6%	3941
Tolima	28.8%	26.5%	32.6%	11.3%	0.7%	5128
Tuluá	27.6%	28.3%	35.4%	8.1%	0.6%	1315
Tumaco	28.2%	26.6%	30.8%	12.8%	1.5%	872
Tunja	25.1%	20.6%	43.6%	9.5%	1.1%	1177
Turbo	28.6%	29.5%	28.7%	11.2%	2.0%	804
Uribe	30.9%	30.9%	27.5%	10.7%	0.0%	149
Valle del Cauca	28.6%	26.9%	33.4%	9.8%	1.4%	4711
Valledupar	28.6%	25.4%	33.0%	11.6%	1.4%	2687
Vaupés	25.0%	0.0%	25.0%	0.0%	50.0%	4
Vichada	25.8%	23.1%	35.4%	13.5%	2.2%	229
Villavicencio	25.8%	24.2%	39.4%	9.7%	0.8%	3070
Yopal	22.8%	24.6%	41.1%	11.1%	0.3%	987
Yumbo	26.2%	25.8%	36.4%	10.3%	1.4%	737
Zipaquirá	27.1%	22.8%	40.5%	9.2%	0.5%	852
Colombia	27.0%	24.8%	35.8%	11.0%	1.4%	275339

*Es posible que los porcentajes mostrados no sumen exactamente 100 debido a aproximaciones decimales.

 Responde las preguntas 40 y 41 de acuerdo con la siguiente información:

El matemático Leonard Euler demostró que la siguiente relación se cumple para todos los poliedros:

$$C + V - A = 2 \quad \text{donde:}$$

C = número de caras.

V = número de vértices.

A = número de aristas.

• Pregunta 40.

El cubo cumple esta relación porque su número de caras, vértices y aristas es, respectivamente

- A. 3, 4 y 5
- B. 3, 8 y 9
- C. 6, 4 y 8
- D. 6, 8 y 12

• Estructura

Competencia	Comunicación, representación y modelación
Componente	Geométrico - métrico
Afirmación	Representar y describir propiedades de objetos tridimensionales desde diferentes posiciones y vistas.
Nivel de desempeño	Avanzado
Respuesta Correcta	D

• Resultados a nivel nacional y de Entidad Territorial Certificada (ETC)

ETC/País	A	B	C	D	Omisión y multimarca	Nº estudiantes
Amazonas	29.3%	20.0%	28.0%	19.5%	3.2%	410
Antioquia	25.8%	20.1%	27.0%	25.8%	1.3%	13194
Apartadó	26.7%	24.0%	26.1%	22.3%	0.9%	779
Arauca	27.4%	18.8%	28.7%	24.2%	1.0%	1239
Armenia	25.8%	20.7%	28.2%	24.5%	0.7%	1846
Atlántico	29.2%	21.7%	26.8%	20.6%	1.7%	3385
Barrancabermeja	27.0%	19.5%	25.7%	26.5%	1.3%	1305
Barranquilla	25.9%	18.5%	25.9%	28.2%	1.5%	6501
Bello	25.7%	18.1%	24.9%	30.5%	0.8%	2366
Bogotá, D.C.	22.0%	14.8%	25.5%	34.8%	3.0%	46573
Bolívar	29.0%	21.5%	28.1%	19.7%	1.7%	5373
Boyacá	24.2%	19.0%	28.6%	27.6%	0.6%	5615
Bucaramanga	23.6%	15.4%	23.8%	36.7%	0.5%	3743
Buenaventura	30.0%	21.1%	25.7%	20.1%	3.1%	1742
Buga	25.0%	21.3%	25.8%	24.6%	3.3%	635
Caldas	29.7%	20.9%	25.9%	22.8%	0.7%	3340
Cali	26.8%	18.6%	25.3%	26.9%	2.4%	12346
Caquetá	27.8%	22.0%	28.4%	21.1%	0.8%	1125
Cartagena	28.0%	20.2%	25.5%	24.8%	1.6%	6521
Cartago	23.0%	20.2%	29.6%	26.2%	1.0%	608
Casanare	28.3%	20.1%	28.9%	21.4%	1.4%	1435
Cauca	28.1%	19.0%	25.8%	25.4%	1.7%	5697
Cesar	30.0%	19.2%	26.6%	23.6%	0.6%	3688
Chocó	28.7%	22.6%	27.3%	19.2%	2.1%	1409
Chía	20.5%	14.1%	27.3%	37.6%	0.5%	971
Ciénaga	28.4%	20.6%	28.8%	21.2%	1.1%	747
Cundinamarca	23.9%	17.3%	26.5%	31.2%	1.0%	9587
Córdoba	28.5%	22.2%	27.4%	20.5%	1.4%	6076
Cúcuta	26.7%	17.5%	27.2%	27.9%	0.7%	4355
Dosquebradas	24.9%	18.3%	28.1%	27.8%	0.9%	931
Duitama	19.7%	15.6%	23.7%	40.8%	0.3%	951
Envigado	20.3%	14.6%	23.0%	41.1%	0.9%	1332
Facatativá	22.0%	16.5%	25.1%	36.5%	0.0%	790
Florencia	29.3%	21.2%	27.2%	21.4%	0.9%	933
Floridablanca	23.3%	13.5%	27.2%	34.9%	1.1%	1552
Fusagasugá	23.7%	16.5%	25.9%	32.8%	1.2%	854
Girardot	26.0%	19.4%	30.2%	22.7%	1.6%	731

Continúa en la siguiente página

GRADO 9° - MATEMÁTICAS

ETC/País	A	B	C	D	Omisión y multimarca	N° estudiantes
Girón	25.9%	19.0%	24.9%	29.2%	1.0%	715
Guainía	0.0%	0.0%	50.0%	50.0%	0.0%	2
Guaviare	27.3%	22.6%	28.7%	18.4%	3.0%	495
Huila	26.7%	19.7%	28.3%	24.5%	0.8%	4002
Ibagué	25.9%	18.6%	26.5%	27.9%	1.0%	3312
Ipiales	23.2%	19.2%	28.1%	28.9%	0.6%	723
Itagüí	24.0%	18.0%	24.3%	31.4%	2.3%	1269
Jamundí	28.9%	21.2%	25.6%	23.5%	0.7%	684
La Guajira	26.4%	20.2%	29.2%	22.0%	2.2%	1356
Lorica	29.2%	21.4%	29.8%	18.9%	0.8%	931
Magangué	33.1%	21.8%	27.7%	15.7%	1.7%	752
Magdalena	29.5%	23.6%	25.6%	20.2%	1.2%	3733
Maicao	31.5%	22.0%	26.8%	17.3%	2.4%	850
Malambo	28.6%	18.4%	24.0%	27.7%	1.3%	559
Manizales	25.7%	20.7%	26.4%	26.4%	0.8%	2372
Medellín	24.4%	18.0%	26.0%	30.2%	1.4%	13276
Meta	25.4%	21.0%	27.7%	24.5%	1.4%	2485
Montería	26.7%	20.7%	25.8%	25.2%	1.6%	2838
Mosquera	20.6%	16.2%	27.2%	35.7%	0.4%	773
Nariño	25.7%	18.6%	25.2%	28.0%	2.4%	4307
Neiva	25.8%	18.0%	26.3%	29.4%	0.5%	2436
Norte de Santander	27.6%	19.5%	25.9%	26.1%	0.9%	3655
Palmira	25.3%	15.3%	25.6%	32.0%	1.8%	1675
Pasto	23.6%	15.7%	25.3%	34.5%	0.8%	2702
Pereira	24.8%	19.6%	27.5%	27.0%	1.1%	2788
Piedecuesta	21.9%	18.2%	28.5%	30.5%	0.8%	855
Pitalito	25.2%	19.2%	29.8%	25.4%	0.4%	765
Popayán	27.4%	16.7%	24.4%	29.8%	1.9%	1835
Putumayo	29.2%	21.0%	27.0%	22.1%	0.8%	1990
Quibdó	26.5%	25.8%	26.4%	17.9%	3.4%	879
Quindío	26.9%	23.3%	26.5%	22.6%	0.7%	1688
Riohacha	26.1%	20.0%	29.1%	23.6%	1.3%	959
Rionegro	24.0%	18.7%	27.0%	29.8%	0.6%	830
Risaralda	28.4%	21.6%	27.1%	22.3%	0.6%	1502
Sabaneta	17.2%	14.1%	26.5%	40.6%	1.6%	377
Sahagún	26.0%	20.2%	28.8%	24.0%	0.9%	791
San Andrés	25.7%	24.0%	29.4%	18.9%	2.0%	354
Santa Marta	28.0%	19.9%	27.0%	23.4%	1.7%	2901
Santander	26.5%	17.1%	25.9%	29.7%	0.7%	4609

Continúa en la siguiente página



ETC/País	A	B	C	D	Omisión y multimarca	N° estudiantes
Sincelejo	26.0%	19.0%	25.7%	28.6%	0.7%	2119
Soacha	25.3%	17.0%	25.7%	31.3%	0.8%	3301
Sogamoso	24.3%	13.7%	28.2%	33.5%	0.3%	964
Soledad	29.4%	19.5%	26.0%	24.0%	1.1%	2582
Sucre	28.3%	20.1%	28.3%	22.1%	1.2%	3941
Tolima	27.6%	21.1%	26.9%	23.4%	1.0%	5128
Tuluá	27.5%	21.4%	25.6%	24.8%	0.7%	1315
Tumaco	29.9%	19.4%	24.9%	23.9%	1.9%	872
Tunja	20.6%	13.8%	26.4%	37.8%	1.4%	1177
Turbo	29.4%	24.3%	25.5%	18.7%	2.2%	804
Uribe	22.8%	31.5%	28.9%	16.1%	0.7%	149
Valle del Cauca	28.6%	21.2%	27.2%	21.3%	1.7%	4711
Valledupar	31.0%	19.6%	24.3%	23.5%	1.6%	2687
Vaupés	0.0%	25.0%	0.0%	25.0%	50.0%	4
Vichada	26.6%	24.9%	28.8%	17.5%	2.2%	229
Villavicencio	27.2%	19.3%	27.3%	25.4%	0.8%	3070
Yopal	26.6%	17.2%	27.7%	28.1%	0.4%	987
Yumbo	27.7%	20.1%	27.7%	23.2%	1.4%	737
Zipaquirá	21.8%	15.7%	25.9%	35.9%	0.6%	852
Colombia	25.8%	18.5%	26.3%	27.8%	1.6%	275339

*Es posible que los porcentajes mostrados no sumen exactamente 100 debido a aproximaciones decimales.

• Pregunta 41.

Si un poliedro tiene 12 caras y 30 aristas, ¿cuál es su número de vértices?

- A. 18
- B. 20
- C. 36
- D. 42

• Estructura

Competencia	Planteamiento y resolución de problemas
Componente	Geométrico - métrico
Afirmación	Resolver y formular problemas usando modelos geométricos.
Nivel de desempeño	Avanzado
Respuesta Correcta	B

• Resultados a nivel nacional y de Entidad Territorial Certificada (ETC)

ETC/País	A	B	C	D	Omisión y multimarca	Nº estudiantes
Amazonas	21.0%	21.0%	18.5%	36.1%	3.4%	410
Antioquia	26.2%	26.5%	17.1%	28.8%	1.4%	13194
Apartadó	25.4%	25.5%	16.4%	31.7%	0.9%	779
Arauca	29.6%	26.4%	16.9%	26.3%	0.8%	1239
Armenia	28.9%	30.4%	16.7%	22.9%	1.1%	1846
Atlántico	23.4%	24.0%	15.8%	34.9%	1.8%	3385
Barrancabermeja	27.1%	30.3%	16.1%	25.3%	1.2%	1305
Barranquilla	26.2%	31.2%	15.2%	25.7%	1.7%	6501
Bello	26.9%	31.8%	19.5%	21.0%	0.8%	2366
Bogotá, D.C.	27.5%	34.0%	15.4%	20.0%	3.2%	46573
Bolívar	22.0%	23.1%	17.7%	35.2%	2.0%	5373
Boyacá	27.8%	28.4%	17.9%	25.0%	0.9%	5615
Bucaramanga	29.3%	37.1%	14.5%	18.4%	0.7%	3743
Buenaventura	23.0%	21.0%	18.3%	34.4%	3.4%	1742
Buga	22.8%	35.6%	16.5%	21.7%	3.3%	635
Caldas	26.5%	27.3%	18.2%	27.1%	0.9%	3340
Cali	26.0%	31.8%	15.6%	24.2%	2.5%	12346
Caquetá	26.9%	26.1%	15.5%	30.0%	1.4%	1125
Cartagena	24.6%	29.2%	15.5%	28.8%	1.8%	6521
Cartago	26.3%	28.9%	17.4%	25.8%	1.5%	608
Casanare	26.2%	28.5%	17.8%	25.9%	1.7%	1435
Cauca	23.1%	25.7%	16.3%	33.2%	1.7%	5697
Cesar	24.1%	26.2%	16.6%	32.0%	1.1%	3688
Chocó	17.6%	18.9%	17.8%	43.6%	2.1%	1409
Chía	29.8%	34.1%	14.0%	21.4%	0.7%	971
Ciénaga	23.4%	23.7%	16.5%	34.8%	1.6%	747
Cundinamarca	28.2%	30.1%	16.9%	23.8%	1.0%	9587
Córdoba	22.8%	23.0%	17.1%	35.5%	1.6%	6076
Cúcuta	28.8%	32.6%	14.9%	22.8%	0.8%	4355
Dosquebradas	29.1%	33.6%	16.3%	20.0%	1.0%	931
Duitama	27.2%	41.6%	11.5%	19.2%	0.4%	951
Envigado	26.9%	41.9%	14.3%	15.4%	1.5%	1332
Facatativá	28.2%	33.3%	18.5%	19.6%	0.4%	790
Florencia	26.2%	30.1%	16.2%	26.7%	0.9%	933
Floridablanca	27.2%	38.1%	14.9%	18.6%	1.2%	1552
Fusagasugá	29.6%	34.4%	16.4%	18.6%	0.9%	854
Girardot	22.6%	29.3%	18.3%	28.3%	1.5%	731

Continúa en la siguiente página

GRADO 9° - MATEMÁTICAS

ETC/País	A	B	C	D	Omisión y multimarca	N° estudiantes
Girón	27.3%	32.2%	16.9%	22.8%	0.8%	715
Guainía	0.0%	50.0%	0.0%	50.0%	0.0%	2
Guaviare	24.0%	22.0%	17.2%	33.1%	3.6%	495
Huila	25.7%	27.2%	17.9%	28.3%	0.9%	4002
Ibagué	29.8%	31.0%	15.5%	22.4%	1.2%	3312
Ipiales	27.2%	30.7%	16.9%	24.2%	1.0%	723
Itagüí	27.0%	31.4%	18.4%	20.7%	2.4%	1269
Jamundí	26.0%	25.7%	16.8%	30.3%	1.2%	684
La Guajira	25.4%	25.6%	15.2%	31.5%	2.4%	1356
Lorica	21.8%	21.6%	15.8%	39.1%	1.7%	931
Magangué	23.4%	24.9%	16.6%	33.9%	1.2%	752
Magdalena	21.5%	21.4%	16.2%	39.3%	1.6%	3733
Maicao	27.4%	23.6%	15.5%	31.1%	2.4%	850
Malambo	25.2%	24.0%	15.2%	33.8%	1.8%	559
Manizales	28.5%	30.6%	18.3%	21.8%	0.9%	2372
Medellín	27.4%	32.4%	16.7%	22.0%	1.5%	13276
Meta	26.0%	26.5%	18.0%	28.0%	1.4%	2485
Montería	25.9%	26.4%	17.7%	28.1%	1.9%	2838
Mosquera	27.0%	30.8%	19.1%	22.3%	0.8%	773
Nariño	25.6%	26.3%	16.4%	29.1%	2.5%	4307
Neiva	28.4%	31.2%	16.2%	23.4%	0.9%	2436
Norte de Santander	28.2%	29.3%	15.6%	26.0%	1.0%	3655
Palmira	24.3%	33.4%	15.9%	24.7%	1.6%	1675
Pasto	27.6%	34.9%	15.2%	21.3%	1.0%	2702
Pereira	29.1%	33.5%	15.0%	21.2%	1.2%	2788
Piedecuesta	26.8%	35.7%	15.4%	21.5%	0.6%	855
Pitalito	29.5%	30.6%	15.4%	23.9%	0.5%	765
Popayán	26.6%	32.9%	14.3%	24.1%	2.1%	1835
Putumayo	26.2%	26.0%	17.9%	28.8%	1.1%	1990
Quibdó	24.2%	23.0%	15.8%	33.4%	3.5%	879
Quindío	26.6%	28.1%	18.6%	25.2%	1.5%	1688
Riohacha	24.2%	26.0%	18.0%	30.2%	1.6%	959
Rionegro	27.2%	34.2%	16.7%	20.8%	1.0%	830
Risaralda	26.2%	25.0%	17.3%	30.3%	1.2%	1502
Sabaneta	28.4%	37.1%	11.9%	19.6%	2.9%	377
Sahagún	23.0%	24.0%	17.3%	34.4%	1.3%	791
San Andrés	21.8%	31.4%	18.1%	26.3%	2.5%	354
Santa Marta	25.6%	28.5%	16.0%	27.9%	2.0%	2901
Santander	27.6%	31.4%	15.6%	24.5%	0.8%	4609

Continúa en la siguiente página

ETC/País	A	B	C	D	Omisión y multimarca	N° estudiantes
Sincelejo	26.1%	29.6%	13.2%	30.0%	1.2%	2119
Soacha	29.7%	29.9%	16.6%	23.0%	0.8%	3301
Sogamoso	30.0%	34.5%	15.7%	19.5%	0.3%	964
Soledad	26.8%	28.5%	16.4%	27.0%	1.3%	2582
Sucre	22.5%	23.1%	16.5%	36.7%	1.1%	3941
Tolima	26.3%	24.3%	16.6%	31.9%	0.9%	5128
Tuluá	25.3%	30.3%	17.7%	25.9%	0.8%	1315
Tumaco	24.3%	20.8%	16.3%	36.5%	2.2%	872
Tunja	28.6%	33.8%	16.1%	20.0%	1.5%	1177
Turbo	19.0%	24.8%	18.7%	34.5%	3.1%	804
Uribe	30.9%	26.2%	18.8%	23.5%	0.7%	149
Valle del Cauca	24.8%	27.0%	16.4%	30.0%	1.7%	4711
Valledupar	27.1%	27.3%	14.6%	29.5%	1.5%	2687
Vaupés	0.0%	0.0%	25.0%	25.0%	50.0%	4
Vichada	27.5%	21.0%	19.7%	30.6%	1.3%	229
Villavicencio	27.3%	33.3%	16.3%	22.1%	1.1%	3070
Yopal	29.6%	31.7%	18.0%	19.6%	1.1%	987
Yumbo	25.1%	27.3%	18.6%	27.8%	1.2%	737
Zipaquirá	29.8%	33.3%	16.1%	20.1%	0.7%	852
Colombia	26.4%	29.7%	16.3%	25.9%	1.7%	275339

*Es posible que los porcentajes mostrados no sumen exactamente 100 debido a aproximaciones decimales.

• **Pregunta 42.**

Un carpintero construye un mueble que tiene cajones como el que aparece en la siguiente figura:

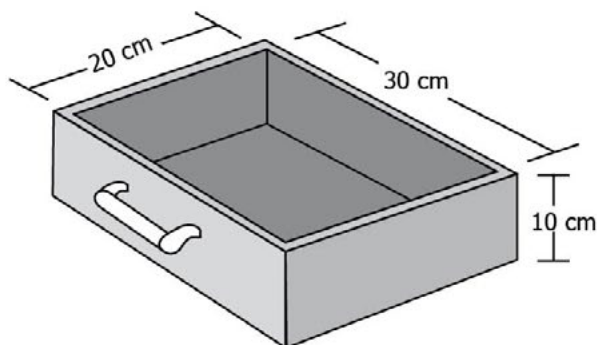

¿Cuál es la capacidad en cm^3 de uno de los cajones del mueble?

- A. 60 cm^3
- B. 500 cm^3
- C. 4000 cm^3
- D. 6000 cm^3

• **Estructura**

Competencia	Comunicación, representación y modelación
Componente	Geométrico - métrico
Afirmación	Diferenciar magnitudes de un objeto y relacionar las dimensiones de éste con la determinación de las magnitudes.
Nivel de desempeño	Avanzado
Respuesta Correcta	D

• **Resultados a nivel nacional y de Entidad Territorial Certificada (ETC)**

ETC/País	A	B	C	D	Omisión y multimarca	N° estudiantes
Amazonas	56.8%	14.1%	10.5%	15.4%	3.2%	410
Antioquia	54.3%	14.8%	9.1%	19.8%	1.9%	13194
Apartadó	51.7%	16.4%	9.8%	20.8%	1.3%	779
Arauca	54.3%	13.5%	9.5%	21.5%	1.1%	1239
Armenia	50.3%	18.4%	10.5%	19.8%	0.9%	1846
Atlántico	62.1%	12.1%	7.1%	17.4%	1.3%	3385
Barrancabermeja	51.7%	16.6%	8.4%	22.4%	1.0%	1305
Barranquilla	56.3%	12.7%	8.6%	20.8%	1.6%	6501
Bello	51.1%	16.4%	9.9%	21.6%	0.9%	2366
Bogotá, D.C.	47.2%	16.4%	8.0%	25.2%	3.2%	46573
Bolívar	58.8%	11.7%	9.2%	18.2%	2.0%	5373
Boyacá	51.6%	15.2%	8.4%	23.9%	0.8%	5615
Bucaramanga	46.4%	14.3%	8.3%	30.3%	0.7%	3743
Buenaventura	60.3%	13.4%	8.5%	14.1%	3.6%	1742
Buga	50.6%	17.8%	9.6%	18.9%	3.1%	635
Caldas	57.7%	13.8%	8.7%	18.7%	1.1%	3340
Cali	52.3%	15.5%	8.4%	21.6%	2.3%	12346
Caquetá	53.2%	12.4%	10.6%	22.8%	1.1%	1125
Cartagena	56.0%	12.9%	8.7%	21.1%	1.4%	6521
Cartago	53.5%	14.0%	10.5%	20.6%	1.5%	608
Casanare	53.9%	15.8%	10.2%	18.2%	1.9%	1435
Cauca	57.5%	10.9%	7.7%	22.0%	1.9%	5697
Cesar	60.4%	11.9%	7.4%	19.5%	0.7%	3688
Chocó	61.3%	12.3%	8.3%	15.3%	2.8%	1409
Chía	40.7%	18.3%	9.0%	31.3%	0.7%	971
Ciénaga	60.9%	13.3%	11.4%	13.3%	1.2%	747
Cundinamarca	52.5%	15.6%	8.2%	22.5%	1.2%	9587
Córdoba	60.1%	13.1%	9.1%	16.2%	1.6%	6076
Cúcuta	50.6%	14.0%	8.2%	26.2%	0.9%	4355
Dosquebradas	51.2%	15.4%	10.1%	22.4%	0.9%	931
Duitama	40.5%	15.5%	7.9%	35.8%	0.4%	951
Envigado	43.1%	15.2%	7.6%	32.6%	1.6%	1332
Facatativá	51.5%	17.3%	7.3%	23.5%	0.3%	790
Florencia	54.1%	15.0%	9.8%	20.0%	1.1%	933
Floridablanca	48.9%	14.7%	8.3%	27.1%	1.0%	1552
Fusagasugá	52.9%	15.2%	8.2%	22.2%	1.4%	854
Girardot	58.5%	15.2%	10.5%	14.4%	1.4%	731

Continúa en la siguiente página

GRADO 9° - MATEMÁTICAS

ETC/País	A	B	C	D	Omisión y multimarca	N° estudiantes
Girón	57.2%	15.7%	8.3%	18.3%	0.6%	715
Guainía	50.0%	0.0%	50.0%	0.0%	0.0%	2
Guaviare	53.1%	14.5%	8.5%	20.6%	3.2%	495
Huila	57.3%	13.7%	7.7%	20.3%	1.0%	4002
Ibagué	56.1%	15.6%	7.4%	19.5%	1.4%	3312
Ipiales	48.5%	13.7%	9.1%	27.7%	1.0%	723
Itagüí	49.2%	18.2%	10.6%	19.6%	2.4%	1269
Jamundí	62.0%	15.2%	9.1%	12.4%	1.3%	684
La Guajira	58.2%	12.5%	7.3%	19.6%	2.4%	1356
Lorica	59.4%	14.5%	11.0%	14.1%	1.1%	931
Magangué	62.9%	10.5%	7.8%	16.6%	2.1%	752
Magdalena	61.6%	12.8%	8.3%	15.9%	1.5%	3733
Maicao	55.8%	14.6%	11.3%	16.5%	1.9%	850
Malambo	60.6%	10.7%	7.7%	19.5%	1.4%	559
Manizales	51.4%	16.9%	9.6%	21.3%	0.8%	2372
Medellín	49.4%	17.9%	10.1%	20.9%	1.8%	13276
Meta	54.3%	15.4%	9.2%	19.5%	1.6%	2485
Montería	57.2%	14.2%	8.5%	18.2%	1.9%	2838
Mosquera	51.6%	20.1%	8.2%	19.1%	1.0%	773
Nariño	53.3%	10.2%	7.0%	27.3%	2.2%	4307
Neiva	53.5%	14.4%	8.0%	23.2%	0.9%	2436
Norte de Santander	54.6%	13.1%	7.4%	23.9%	0.9%	3655
Palmira	49.5%	14.8%	7.3%	26.8%	1.6%	1675
Pasto	49.9%	13.2%	7.1%	28.9%	0.8%	2702
Pereira	51.2%	15.5%	9.0%	22.9%	1.4%	2788
Piedecuesta	51.1%	13.1%	8.7%	26.2%	0.9%	855
Pitalito	55.4%	14.5%	9.3%	20.1%	0.7%	765
Popayán	52.3%	14.6%	9.6%	21.1%	2.3%	1835
Putumayo	53.6%	14.2%	9.0%	22.3%	1.0%	1990
Quibdó	60.4%	10.5%	10.6%	14.9%	3.6%	879
Quindío	52.0%	19.1%	9.7%	18.0%	1.2%	1688
Riohacha	59.5%	14.5%	8.0%	16.3%	1.7%	959
Rionegro	46.9%	17.2%	8.3%	26.1%	1.4%	830
Risaralda	56.8%	11.9%	9.5%	20.8%	1.1%	1502
Sabaneta	44.8%	17.5%	6.9%	27.9%	2.9%	377
Sahagún	60.2%	13.9%	8.2%	16.7%	1.0%	791
San Andrés	57.3%	13.0%	10.2%	17.5%	2.0%	354
Santa Marta	57.1%	13.8%	9.9%	17.4%	1.9%	2901
Santander	51.7%	13.6%	7.4%	26.5%	0.8%	4609

Continúa en la siguiente página



ETC/País	A	B	C	D	Omisión y multimarca	N° estudiantes
Sincelejo	56.3%	12.6%	8.0%	22.0%	1.1%	2119
Soacha	57.9%	14.4%	8.5%	18.4%	0.8%	3301
Sogamoso	43.0%	17.8%	8.2%	30.7%	0.2%	964
Soledad	58.7%	13.6%	8.0%	18.6%	1.1%	2582
Sucre	60.1%	12.3%	8.1%	18.5%	1.1%	3941
Tolima	58.3%	14.3%	8.3%	18.1%	1.0%	5128
Tuluá	55.2%	17.3%	8.6%	18.0%	0.9%	1315
Tumaco	58.0%	11.9%	10.1%	17.5%	2.4%	872
Tunja	46.5%	17.1%	8.9%	25.6%	2.0%	1177
Turbo	62.2%	14.1%	8.7%	11.6%	3.5%	804
Uribe	63.8%	18.8%	7.4%	9.4%	0.7%	149
Valle del Cauca	56.8%	15.5%	8.4%	17.7%	1.5%	4711
Valledupar	58.5%	13.7%	6.6%	19.8%	1.4%	2687
Vaupés	25.0%	0.0%	0.0%	0.0%	75.0%	4
Vichada	64.6%	14.0%	5.2%	14.4%	1.7%	229
Villavicencio	51.4%	16.2%	9.3%	22.2%	1.0%	3070
Yopal	50.8%	17.1%	8.4%	22.9%	0.8%	987
Yumbo	55.2%	15.2%	10.6%	16.8%	2.2%	737
Zipaquirá	50.6%	14.6%	10.0%	24.6%	0.2%	852
Colombia	53.2%	14.8%	8.5%	21.7%	1.8%	275339

*Es posible que los porcentajes mostrados no sumen exactamente 100 debido a aproximaciones decimales.

